

Op-Amp Practical Applications: Design, Simulation and Implementation
Prof. Hardik Jeetendra Pandya
Department of Electronic Systems Engineering
Indian Institute of Science, Bangalore

Lecture - 35

Experiment on ECG Signal Acquisition, Conditioning and Processing of PQRST wave to Compute BPM using Op-Amps

Welcome to the module and in the last module, we were discussing about ECG signal conditioning and signal processing using operational amplifiers. So, to continuation with our previous module, so in last module we have also discussed about what are all the factors that influence our output ECG signal and what processing steps that we are doing in order to remove the unwanted signals, those are available in the ECG. In this module, we will see the other type of filtering unit which is essential in order to remove unwanted signal in that.

So, last module we have you seen high pass filtering, low pass filtering and what frequency to be used we were discussing in the last module. In this module, we will see a notch filtering which is used to remove the power line interference and we will be using a narrow band notch filter. The reason is that we required only to remove 50 hertz signal and anyway the odd multiples of the power line interference was removed by using low pass filtering. So, our range of the complete interest is in the range of removal of 50 h signal that is due to our power line interference or the operating frequency of our systems or AC input signal.

So, since we are not interested in any other frequencies, if we can design, if we can design a notch filter with narrow band where the interest of the removal interest is only 50 h, it will be really great. Even if it is not as long as our QRS detection is able to do that as long as if design a filter which cannot remove the actual requirement of our input signal, our job is done.

So, now we will see how do we do the notch filtering using operational amplifiers, how to verify the functionality of the system and what are all the connections that we are making it right and experimentally as well as simulation wise we will see the frequency response as well as in time domain response to understand whether the notch filter is filtering at the 50 h frequency or not, ok. So, similar to that of our previous filtering

modules, even in this case we will be using an active filter. The reason is because of very high input impedance due to the operational amplifiers, we will output impedance and the gain is easy to set using our operational amplifiers.

(Refer Slide Time: 03:07)

Experiment: To Design and Build an Op-amp based ECG Signal Acquisition, Conditioning and Processing of PQRS wave and compute BPM

Notch filter Design:

- $f_c = 1/(2\pi R_1 C_1) = 1/(2\pi * 12 M * 270 p) \approx 50 \text{ Hz}$
- $R_1 = R_2 = 2 R_3$
- $C_1 = C_2 = C_3/2$

1 Hz - 100 Hz

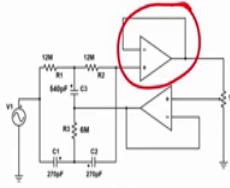

Figure 5

Experimental Procedure:

1. Apply a sinusoidal input signal of 1 V amplitude generated by the signal generator at 50 Hz into the filter (V_{in})
2. Observe both the input and the output voltage on the oscilloscope
3. Change the input frequency from 30 Hz to 80 Hz in steps of 10 Hz and record the output at each frequency
4. Observe the signal generator frequency for which the output is 0.707-times lower than the input signal. This is the -3 dB point. Record this value
5. Verify the operation of a Notch filter

Now, when we look into our experiment, to design and build an op-amp based ECG signal acquisition conditioning and processing of PQRS wave and compute BPM, we will see how to do the notch filtering using the operational amplifiers here. So, if you see as we know the how we know the importance of an notch filtering in an application if we see and we also know how to use a passive notch filter in circuit. It is similar to that of our passive notch filter.

So, we are using two different resistors which are 12 mega and 12 mega and a capacitor C1 C2 which are all 270 picofarad and other resistor 6 mega and 540 picofarad. Now, what makes us to select these particular values? So, since our interest is completely on elimination of 50 hertz signal, if we can calculate our cut-off frequency as you already know the way to calculate are cut-off frequency is $2 \pi R_1 C_1$. So, when we substitute the value of the capacitor as well as a resistor, so we get approximately of 50 hertz and the selection of R2 and R3, R1, R2, R3 should be such a way that, R1 and R2 should be same.

I followed R1 R2 to be same as well as C1 C2 to be same. Similarly the relation between R2 and R2 and R3 is R3 value should be to double than that of our R2 value as well as

sorry R2 value should be double, then R2 and R1 values are double to that of our R3 values. So, that is a reason since we are selecting R1 and R2 as 12 mega. So, R3 should be of 6 mega and similarly, C3 value should be double than C1 and C2 values. So, we are taking C3 capacitors somewhere around 540 picofarads, right.

Now, how do we trace the circuit? So, similar to that of our previous thing, we will connect our input from the signal generator which is of an amplitude of 1 volt and since if we observe here op-amps are just use to provide some buffering or some impedance matching. So, we are not using any kind of a gain in this case. So, when we apply input signal of 1 volt, we get an output also as 1 volt. So, when we keep on changing our input signal from 1 hertz to somewhere around 100 hertz, why do we not to go with below 1 hertz and why do we not to worry about more than 100 hertz?

The reason is that we have already this particular phase of filtering is comes after passing through high pass filtering and low pass filtering and we already know that the high pass filtering, the cut-off frequency somewhere around close to 1 hertz and low pass filtering cut-off frequency somewhere around 100 hertz. Even though when you are looking for the frequency is lower than that as well as higher than that which is, which are not in our interest, we do not have to even test our circuit in that operation in.

So, the complete area of interest, complete frequency of our interest is between 1 hertz to 100 hertz frequency and this particular circuit is designed to remove the narrow band of 50 hertz. So, since 50 hertz is also between this particular frequency, the purpose and the requirement can be completely monitored using this particular range of frequency and when we apply input, we will slowly change different frequencies from 1 hertz to 100 hertz with a factor of 10 hertz in steps. And, we will be observed at what particular frequency the output amplitude is 0.707 times lower than that of the input signal that 0.707 times is because of our minus 3 dB point.

So, if you can calculate the minus 3dB point or if we can know at what frequency that the output is smaller than 0.707 will times smaller than that of input that particular frequency give us the information of our cut-off frequency of our notch filter, right.

(Refer Slide Time: 07:48)

Experiment: To Design and Build an Op-amp based ECG Signal Acquisition, Conditioning and Processing of PQRS wave and compute BPM

Notch filter Design:

- $f_0 = 1/(2\pi \cdot R1 \cdot C1) = 1/(2\pi \cdot 12 \text{ M} \cdot 270 \text{ p}) \approx 50 \text{ Hz}$
- $R1 = R2 = 2 R3$
- $C1 = C2 = C3/2$

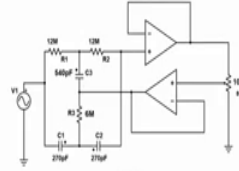

Figure 5

Experimental Procedure:

1. Apply a sinusoidal input signal of 1 V amplitude generated by the signal generator at 50 Hz into the filter (V_{in})
2. Observe both the input and the output voltage on the oscilloscope
3. Change the input frequency from 30 Hz to 80 Hz in steps of 10 Hz and record the output at each frequency
4. Observe the signal generator frequency for which the output is 0.707-times lower than the input signal. This is the -3 dB point. Record this value
5. Verify the operation of a Notch filter

Why this is called notch filter? The reason as we know that when we see the frequencies, this is out the representation of our notch filter. This particular frequency will be completely allowed as we already seen in R at the modules and these particular frequencies is also completely allowed what this particular frequency which is nothing, but a centre frequency are this particular band. Frequencies will not be allowed and that is the reason it is called notch.

That particular notch, that particular brand is not allowed and other than that particular band, all other frequencies are allowed, not allowed in the since it is nothing, but attenuated. We cannot say completely remove. We can say attenuated. Now, we will see the simulation of how exactly the notch filter works by designing the same, the same filter, right and output will be taken at this point, ok.

(Refer Slide Time: 08:55)

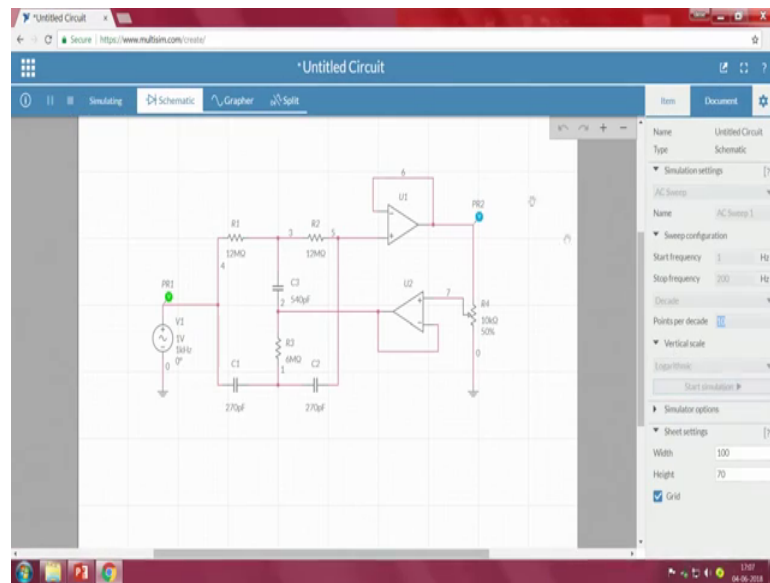

Now, if we see that as similar to that of our previous experiments, how we have done. So, we will go to multisim. We will try to design the same. So, we will take 3 resistors and 3 capacitors. If you remember correct, R1 and R2 should be doubled, then that of our R3 values. So, what I will do is that I will take 3 resistors, the value of this is 6 mega. So, I am replacing the resistance with 6 mega and other resistance should also be 6 mega, sorry 12 mega, 12 mega and 1 resistance should be 6 mega. So, this should be 6 mega resistor and let me delete this. So, easy to create, then other one should be 6 mega R3 resistance should be 6 mega.

Now, we also required 3 capacitances. So, capacitor 1 C1 I am saying it has which is nothing, but 270 picofarads, 270 pico, then 2 capacitors and the value of capacitor should be half of that of our C3 capacitor. So, C3 capacitor is somewhere here, right and the value of this should be doubled than that of our C1 and C2 capacitor which is 540 picofarad. So, whatever the required resistors capacitors we have ranged it here and only this left is connections. So, the passive elements connections will do now, then will go with our active elements required, right which will look similar to that of our circuit if you observe here, right.

Now, the input should be connected at this point. So, what I will do is that I will take AC voltage, connect it here and the other terminal should be connected to the ground. So, we are expected, we are thinking to take a resistance value, sorry the voltage source with an

amplitude of 1 volt peak value. So, peak to peak we can select it has 2 volts 2, right. So, it is easy to understand, relatively it is easy to understand our output voltage. So, we need to op-amps. So, 1 op-amp we are taking it here and ask the purpose of this op-amps are one is to provide and you know impedance mismatching and other one is to provide some offset to the system. So, what we do is that we will flip op-amp.

So, two op amp looks similar to that of our the connections. We look similar to that of our connection that we see in our circuit part, right. I will take one more op-amp rotate it. So, this one should be connected to the second point. The junction of C3 capacitor and R3 capacitor and one part we will take potentiometer. So, the output some percentage is passing through are input. So, this particular terminal has to be connected here, right. So, we made the connections whatever we look at now we will text for the functionality. So, we are following the frequency analysis in order to see how exactly the frequency domain looks like.

So, as remember the notch filter will pass frequencies from 1 hertz to somewhere around you know you know like expect the narrow band frequencies, it will pass all other frequencies. So, in order to verify we will go to AC sweep, we will keep some settings here 1 hertz and the stop frequencies. We may not required up to 1E power done. So, we will go up to somewhere around 200 hertz and the decade value we will say points per decade 10 points per decade, then logarithmic scale, then start simulation, but in order to visualize we have to put our voltage points to one green indicates our input voltage and blue represents are output voltage.

(Refer Slide Time: 14:27)

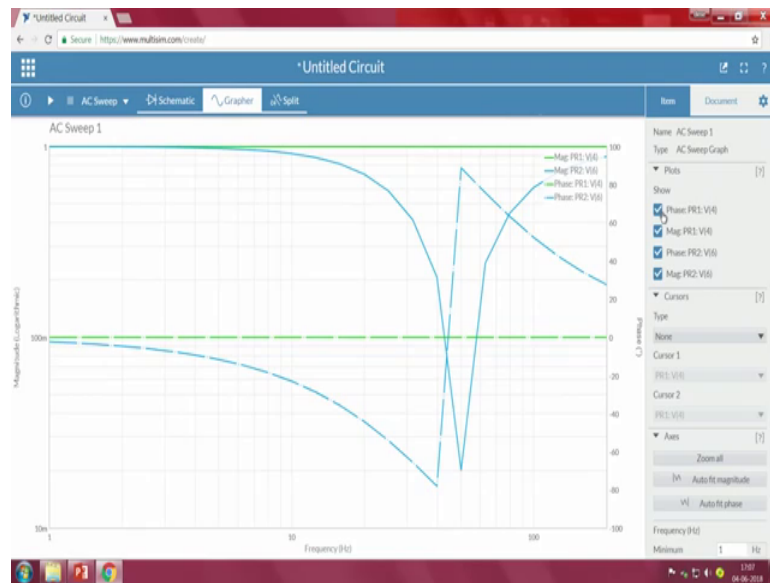

When we start as simulation and we look into the grapher, one thing is clear that if you clearly observe, it has two different frequencies. Sorry input phase as well as magnitude input output phase as well as magnet since we are not interested in the phase 2 we just look into the magnitude.

(Refer Slide Time: 14:40)

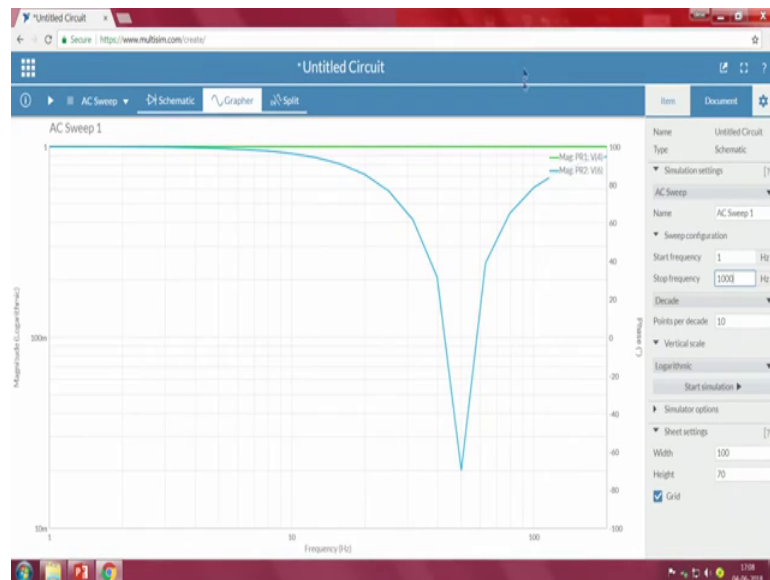

If you see that the output as well as input, right output and input or you know having the maximum amplitude magnitude as 1, right. That means, there is no gain acting the system.

Now, what we do is that we will see, we will try to increase the frequency is to somewhere around 1000 hertz, so that even the output can go to the maximum, write the gain and let me remove the face values. Now, if we can clearly see that this is 10 its a frequency domain. So, if you recall how do we measure in a frequency domain and that in a log scale basically 10 20 30 40 and 50, right 60 70 80 90 100. Now, when we see that we need to know 3 dB line, the 1 2 3, this point right this particular frequency, the frequency at this particular amplitude, right it is a cut-off frequency generally we do, but you know if you see at a frequency of somewhere around 50 hertz right, the magnitude is completely very smaller, right and again and again suddenly after you know just above 50 hertz, it started ranging.

So, when you see the valley it is just like a narrow that is why this is called Narrow Band Filter 2. So, very narrowly we can sharp down, we can cut down into one particular frequency. The reason is that we have, we are we are looking to eliminate or to remove only the 50 hertz noise and other things we are not we are we do not have to remove it. So, that is a reason rather than going with a long range of notch filtering, if you can go with a narrow band of narrow filtering narrowband of our you know narrow filtering, it would be really advantage, so that it can only remove 50 hertz frequency signal.

So, this looks similar to that of our narrow band frequency. Now, how do we understand since most of the cases we may not have a function, we may not have the frequency spectrum to visualize our filter, so what we can do is that we can even analyze the cut-off frequency of the filter by looking into the time domain that is what we are even visualizing in our previous experiments. Now, how do we do that? So, rather than going to AC sweep, we will go to interact to and we will go we will try to change the frequencies slowly from 1 hertz 1 hertz to up to 100 hertz is more than enough and will put it in this spilt mode, ok.

(Refer Slide Time: 17:52)

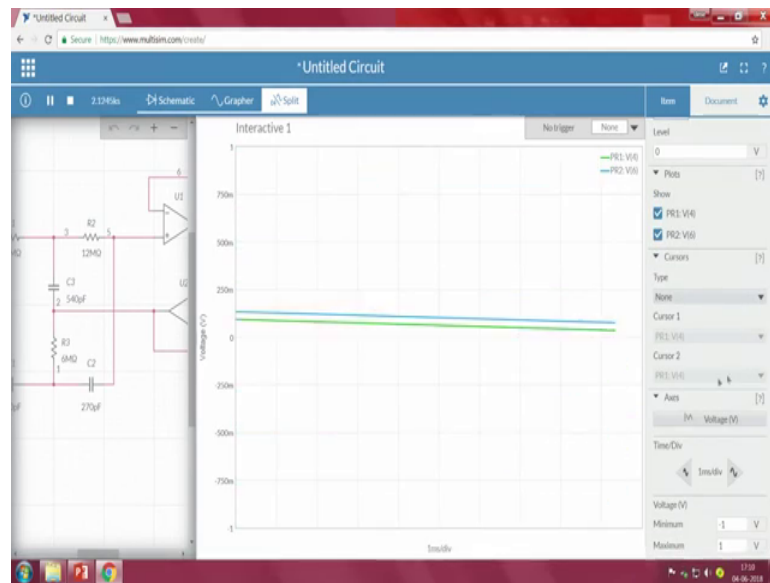

Now, if we observe let me run write know it is 1 volt 1 hertz. Let me change the settings of our time domain of our signal, right.

(Refer Slide Time: 18:01)

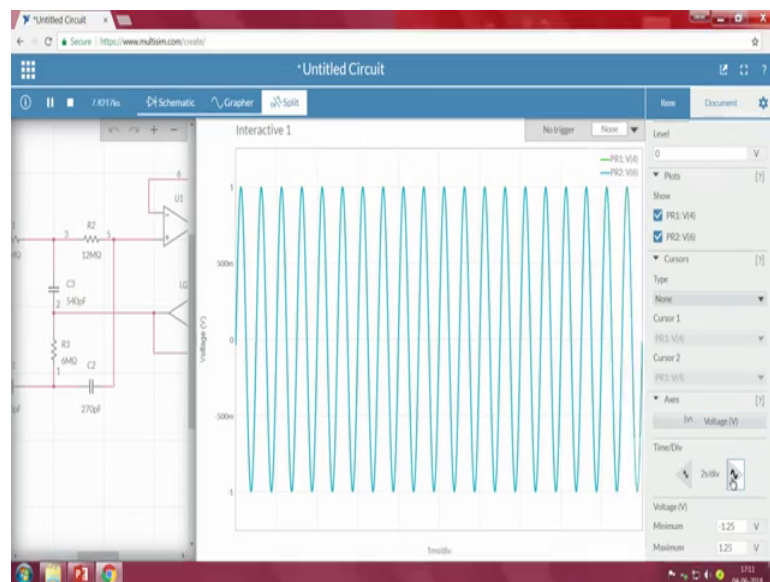

So, we have both the signals if you carefully observe write the reason, the reason why we are showing only one is because one is ahead of other. I mean the green is on the background of the blue colour, ok. We slowly changed our signal frequency at an interval at the steps of 10 hertz.

So, now we will go with 10 hertz. Now, if we observe let me change our time division divisions, right.

(Refer Slide Time: 18:38)

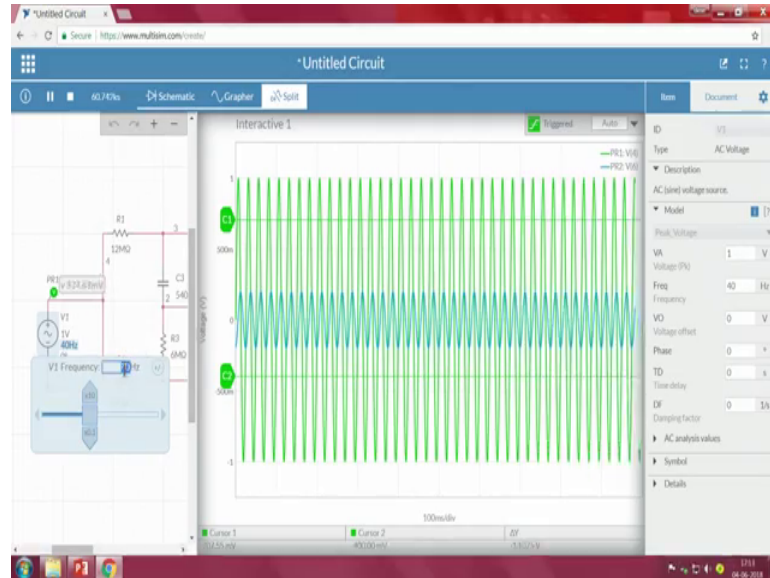

Here we can clearly see that this is our input green colour and this is our output. Now, how do you understand this is the particular point that we have to consider it? So, in order to make our self easy, let us let me create a cursor for us. So, the cursor point should be somewhere around 707 millivolts. So, let me move very close to if we observe here at this point. So, I just keep the cursor at 707. So, this is nothing, but a 3dB line. What we do is that when are output voltage is lower than this particular 707 or R at 707 that is nothing, but are cut-off frequency general we consider in our in our frequency domain.

Now, the input is output is greater than that particular cursor point. So, that means this is not our cut-off frequency. Let me increase to 20 hertz. We increase almost close to, but not exactly right, then 30 hertz. See below that below that 40 very small signal 50.

(Refer Slide Time: 20:03)

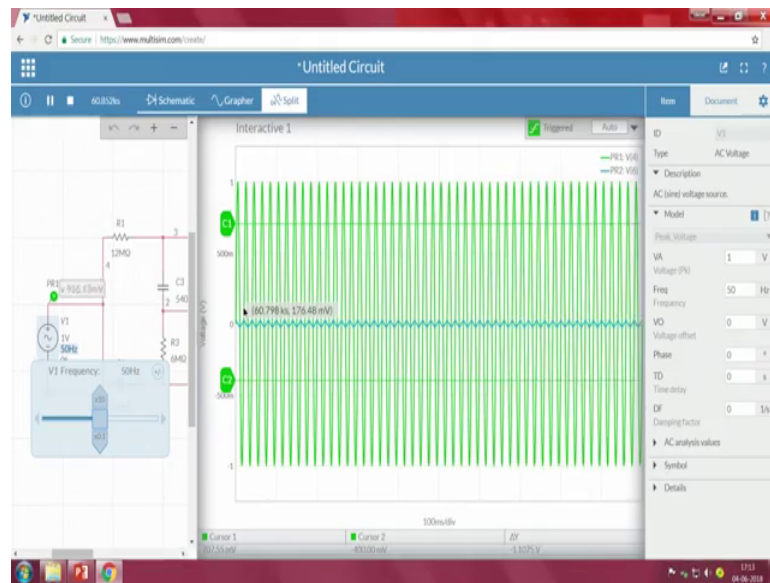

So, that means if we observe that there is a drastic change for every 10 hertz increment right, that is why this is called a narrow band a very drastic change, right. Now, if we slowly increase the input frequency, even you can observe the drastic change in our output signal 2, right. Now, what is the purpose of the op-amp that we have seen here if you observe. So, what we do is that to understand that op-amp will slow will keep to one particular value.

(Refer Slide Time: 20:45)

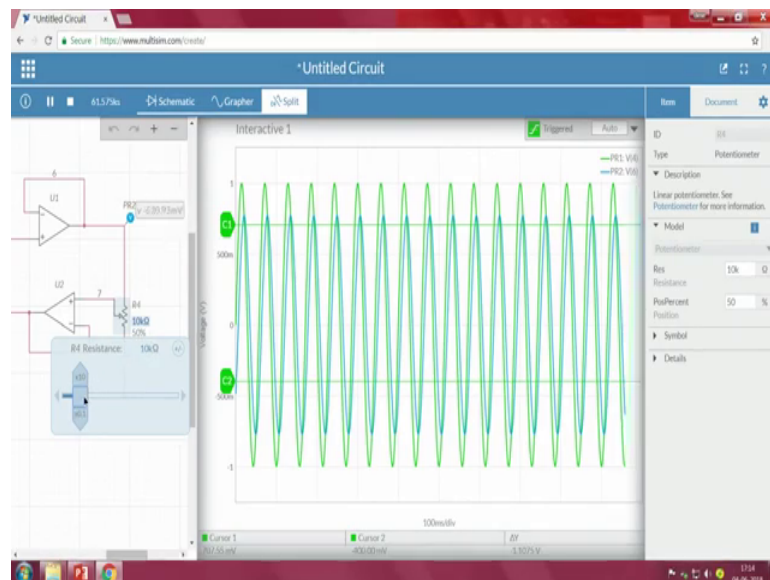

Yeah we will consider this one. Now, we will change this particular resistance, sorry we should be 10 kilo and let me change this value we observe, right. Now, how much band, how much narrow band that we require we can select by using this particular part. Now, we will slowly change once again 17 25 26 30 33, right. At this particular frequency somewhere around 34 right, somewhere around 33.5 if we observe here, it is very close very close to $RC1$. So, what if I increase it ok so if I see that till that particular frequency 39; now it has increased to 39. So, that means we can see at what frequency that we require to have you know the proper cut-off, right.

(Refer Slide Time: 22:32)

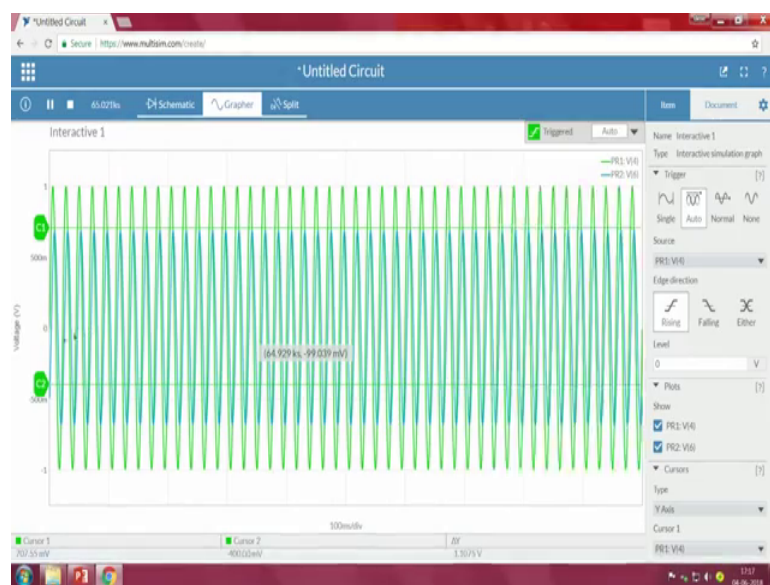

Now, if I slowly increase right 44.5 45, let me see take 45, ok. See there is a drastic change from 44.5 to 45 itself and since are interest somewhere around 50 hertz within the range of plus or minus 5 hertz frequency from 45 hertz to 56 hertz frequency. I am completely eliminating even if it is not even required. What we can do is that even we can change is $R4$ resistant to some other value. So, we can see we can see very drastic change narrow banding of the frequency everything, but that is the problem with this thing is that we can up, when we closely look into the grapher, there is some shift, there is some shift in our output signal 2.

(Refer Slide Time: 23:30)

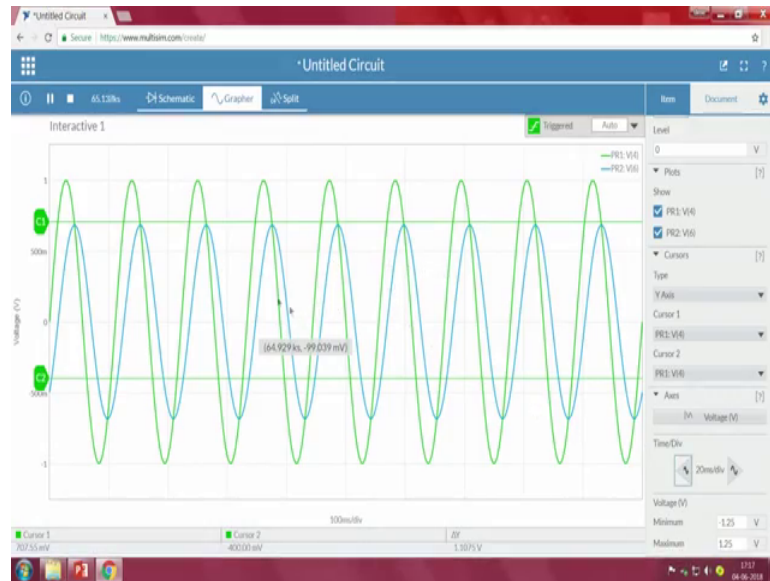

So, to understand let me zoom a little bit, right. So, as long as if we keep on change our now the potentiometer value, it causes to create some kind of a shift in our output signal. So, if that is ok, that is fine if not try to set are you know op-amp, the resistor to one particular value and change our resistance values, but if we are really you know interested in a dam narrow band of frequencies, one good way is changing the resistance value and we can observe that verges drastic change from 44 hertz to 45 hertz itself. And, below that particular value it is completely, it will be completely below the set of and if we see even that go to split and if I slowly increase input frequency 44.5 right at 59 49 hertz almost nothing.

If it is 50 again started increasing; forget about C2 right, but as frequencies you know greater than the value again it follows the input, right. So, this we can clearly understand whether whatever the filter that we have design can cut-off very close to the 50 hertz frequency or not, right. Now, we will see how do we perform an experimental thing?

(Refer Slide Time: 25:12)

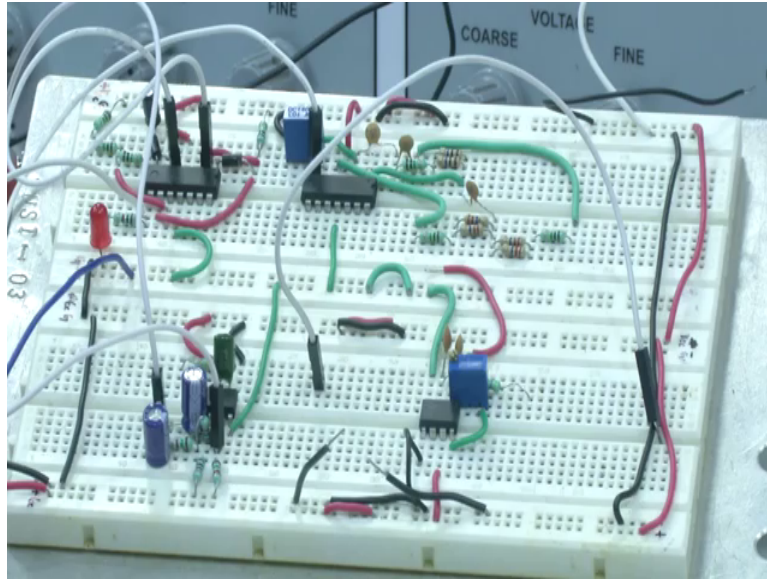

When we will look into a board if we recall this particular portion, this particular portion we have used for both low pass and high pass filtering, right. So, this portion is for low pass filtering, right and this portion is for high pass filtering that we have used. Now, the other part that we are using is notch filtering and that too 50 hertz notch filtering. So, if we recall our resistance value that we have used the time, so somewhere around 12 mega and 6 mega resistor 270 picofarad and 540 picofarad, right.

So, since 12 mega, getting 12 mega resistor is really harder in the market, but we can get 10 mega resistances. So, either you can go with 10 mega plus or 2 mega. So, that is one way or you can use some other combinations in order to get 10 mega value, sorry 12 mega value. So, in this case we have used somewhere around 20 mega and 20 mega connected in parallel and we have connected it and 6 mega also. So, we have we adjusted the resistance value such a way that to get the signal 6 mega resistance and apart from this everything as per the circuit, so that if you observe this point we have a different resistance connected in parallel, right and connected in series, right series parallel again parallel and series and the capacitor, right and both the op-amps we are using from TL 084.

So, TL 084 is a code op-amp; so, there as 4 op-amps in side. So, we are using only two op-amps in this point and this is another part where we have seen even in the simulation where we are changing the shifting are you know the face value or shifting the

narrowband and everything here, right. So, now let me implement in this circuit, so that we will see how exactly it is working. So, input at this point is the junction of both 12 mega and the capacitor.

So, when we see that, this particular point is the input power system and the output is the 7th pin. This pin is the output for us, ok. Now, what I will do is that I will take CRO I will take function generator, I will connect input from the function generator, right. If you remember we are going to use a function generator starting from frequency of 1 hertz to a frequency value of 100 hertz. If you slowly increase our frequency at one particular point, we can see a decrease in our output voltage that frequency at which it is nothing, but 3 dB line.

So, I am connecting the input here and changing the input frequency to somewhere around 1 kHz; so, I will take CRO. So, one terminal connecting it to the ground at the terminal I will be connecting at the same input point, so that we can see what input that we are connecting it to the system, right. So, I have taken CRO 1 CRO probe connected with the same point, right another CRO probe let me connect to the output. So, they should be are this is the ground and they should be our output. The 7th pin is our output. I am connecting it to the output, right. So, let me switch on the circuit. Let me switch on the input signal, auto set it.

(Refer Slide Time: 30:25)

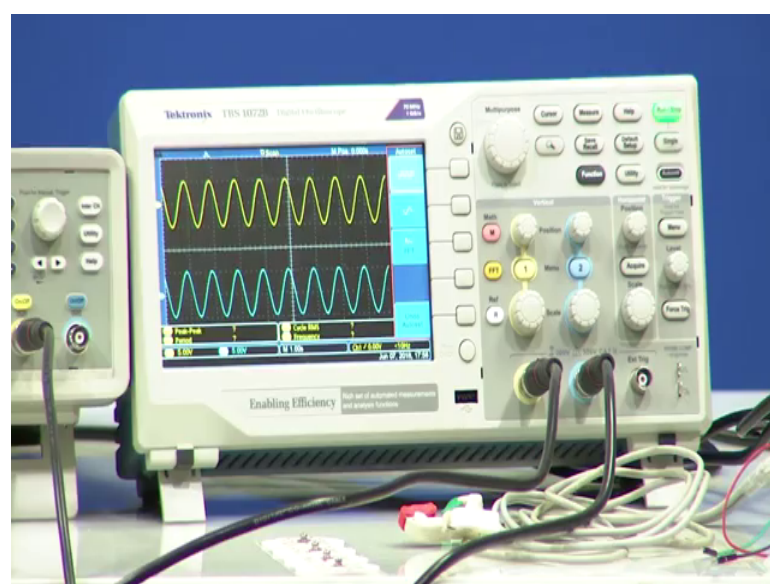

So, when we look into the CRO right, so this is nothing, but our input. The yellow colour line and the blue colour line is our output. So, just to understand what I will do is that I will keep both the signals to the same point at this particular point, so that it is easy for as to compare now 5 volts. So, let me change my amplitude to 1 volt. So, I am setting the amplitude to 2 volts peak to peak. So, there is nothing, but 1 volt peak.

(Refer Slide Time: 31:42)

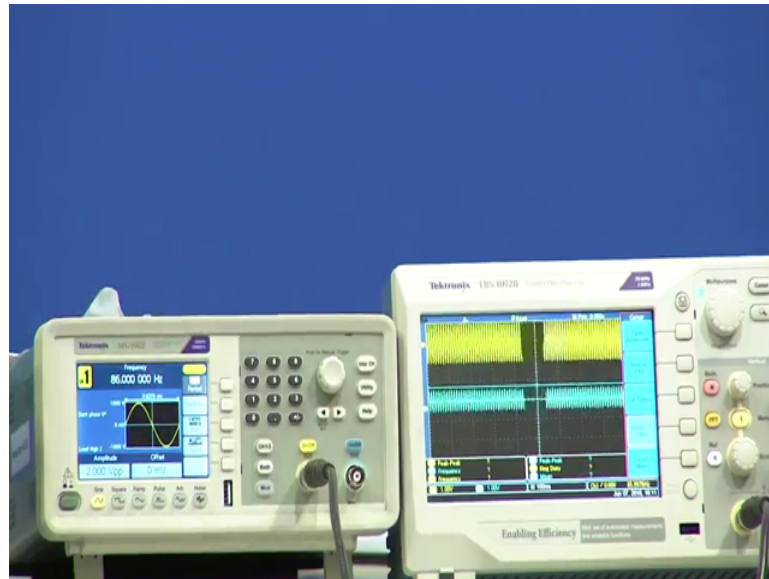

Now, I will zoom this particular. So, if you see one box in this case represents 5 volts, right. Even in this case, one box represents 5 volts. So, let me increase the value one box to 1 volt and even here, ok.

(Refer Slide Time: 31:57)

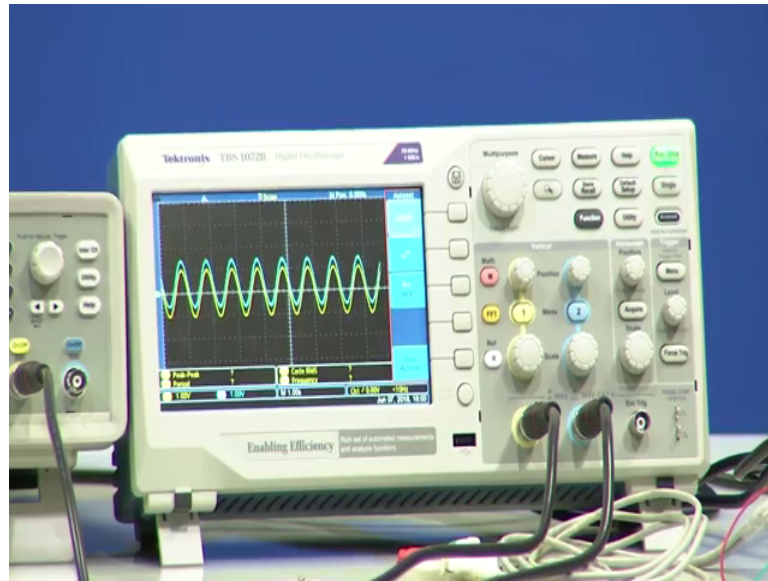

So, there is slightly shift of our output, so that we can adjust by using by changing the pot, right. So, let me change the pot value. When we will look into CRO, we can see we are getting both input and output signal. Now, what we have to do? We have to see whether this whether, but this particular circuit is filtering out the 50 hertz component and other frequencies are passing or not. So, for that we have to change our input frequency and we have to see at what particular frequency the output is below 707 millivolt. So, in order to set 707 millivolt, I will use a cursor.

So, I will go to the cursor and I will make it an amplitude cursor for channel 2. So, I will go for channel 2 and sorry, ok. So, I will change the cursor 1 value 2. So, the peak value when I take, so this is the value and the another channel and moving it somewhere below. So, the peak to peak value when I see delta V it is 2 volts that is cool now. So, this is are ground terminal and this is 720 milli. So, right channel cursor 1 is the difference between both the cursor 1 and cursor 2 is somewhere around 720 millivolts. So, now what I will do is that when we look into the function generator, I will slowly change at a frequency of 20 hertz.

So, now it is at 1 hertz frequency, I will change it to 20, ok. So, 210 first 210 hertz now when we see, right. So, I do not see any difference in below that particular value. So, let me change to 20 hertz even the result at the same 30, even higher than that of the cursor, cursor value 40 slightly higher than that. From here I will slowly increase 41 42 43 44

45, right 46 47 48 49, right; when we observe that somewhere near to 49, somewhere near to 50 hertz. So, when we see the CRO value 50 hertz that is the output is almost below the cursor value, right. When I slowly increase here another an amplitude will be the peak to peak amplitude, we can see it is completely decreasing it, right and if it is increasing again the peak to peak amplitude if you observe starts increasing now, ok.

So, in order to make it narrow band are something what we have to do. We also have to change the resistance value. So, I slightly change the resistance value too, because we need narrow band. So, that is a reason by adjusting here resistance value, we can easily see whether it is creating a narrow or little wider band, right. So, that is a reason I changed the resistance value. I am decreasing somewhere to 53 52 hertz 50 hertz and 49, it is higher. So, there was not much in fact now. So, if we recall our the pot resistance value that we have chosen, so if that same resistance value if I measure and select it right, we can see some adjust in the resistor.

So, we can see it has come down right whereas, if I change the resistance value, the pot the peak to peak voltage value will change it. We can easily see the CRO, right. So, it depends upon whether we require narrow or wide band. So, this pot, the pot that we are using decides it, right. So, this way we can even you know change the notch filtering to be narrow band or little wider band and everything.