

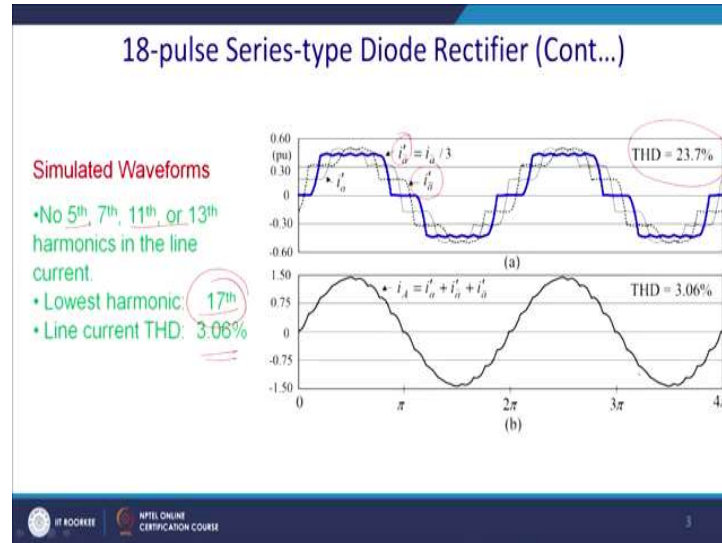

of the 12, you are going to get 11 and thus this primary current  $i_A$  in the star side will be  $i'_a$ . That is the 20-degree phase lead and that is a star-star connection, but it requires a special kind of construction that we require to do it. It gives you delta equal to '0' and this one it will give delta equal to minus 20 degree and we shall see that it can even cancel the harmonic of 11 and 13.

(Refer Slide Time: 02:53)



For this reason, what happens? if you can superimpose these three waveforms, ultimately it leads to the fundamental one. First of all, blue one is a  $i'_a$ . So, that is essentially  $\frac{i_a}{3}$  and thereafter you got this one as  $i_a$  and thereafter you got  $i_a$ . So, this particular waveform may be blue one has that THD of 23 percent if it is fully loaded and once you add all these waveforms. So, then what happened? Till 5th, 7, 11, 13 are been eliminated and since they are eliminated you are left with the next harmonic that is 17th and the 19th.

So, lowest harmonic after fundamental will be the 17th harmonic and thus you can expect the full load THD to be less than around 3 percent and that is quite within all the standard proposed. Because, generally all those want THD to be less than 3 percent and you can be close to the 3 percent in case of the full loading. So, ultimately this will look like this current profile in the star side.

(Refer Slide Time: 04:33)

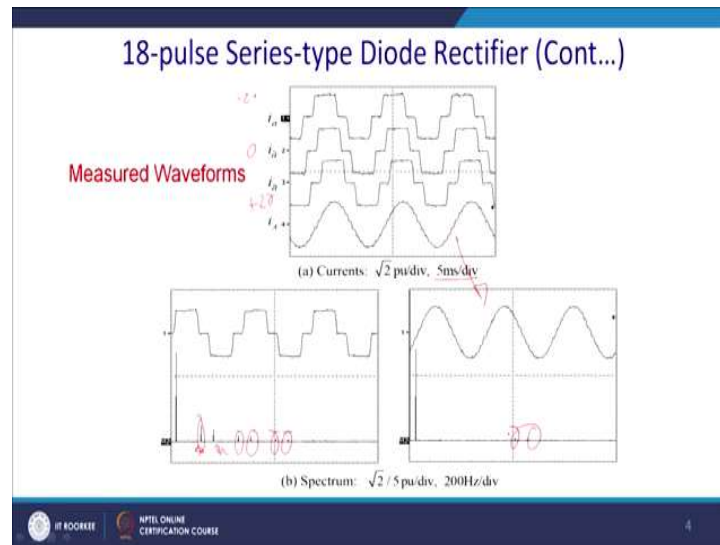

So, this is the waveform which we can see. This is the  $i_a$ , this is a six steps waveform. They are phase shifted by 20 degree. This is minus 20. Thereafter this one is at '0'. We assume that the zero-phase shifted. So, this will be the case and next will be plus 20 degree. So, you can add them together and ultimately you can find that the THD what you were ultimately want and you will construct in a primary side. The reflected current will be the  $i_a$ .

This will have this kind of ripple and ultimately if you see this waveform, this one is fundamental and this one is a real waveform from the experiments. This is the its 5th harmonic, this is a 7th harmonic, this is eleventh and a 13 harmonic. Thereafter this one is 17th and the 19th harmonic. So, if you take the harmonic spectrum the current is in the scale of the root 2 per unit per division because of the peak value.

As you can see that it is 5 millisecond divisions in your oscilloscope or power scope. So, you can see that here it is first harmonic only. Thereafter this one is 17th and this one is 19th. So, all are absent and you can get the desired power quality.

(Refer Slide Time: 06:41)

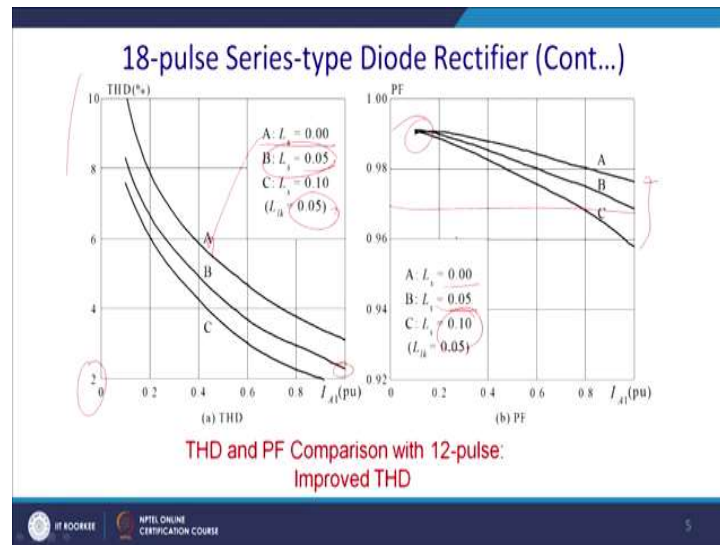

But what is the disadvantage of having it? You require a special kind of construction. I am coming to the problem of the multipulse converters, then only we shall start the PWM converter. Then again, the same analysis what we have done for the 12-pulse converter, we are going to repeat it. So, this is something that, it is  $L_s$  equal to 0.05 and that is 5 percent in terms of the per unit 0.05 and leakage reactance is considered to be 5 percent. As you can see that, this is the THD in light load. The THD will be high for this one which corresponds to the zero-source inductance.

Higher source inductance gives you better THD, but problem will be lower power factor. So, you know you can get less than 2 percent for 'C' having a 10 percent generally source impedance does not occur, but you can get 2 percent. But considering that 5 percent source inductance and you can reach well below 3 percent in the full load condition and thus satisfy your purpose. Same way this is a curve with the power factor for  $L_s$  equal to 0.00 and when there is no source inductance, but it is physically impossible. Then you can get this 'A' which will give you a good power factor.

But power factor is quite good, but THD will be high. But thereafter if you increase the source inductance, then you can also get close to 0.97 as power factor because till 0.95 we do not penalize the customer or the utility does not penalize the customer. Generally, we do not have a source inductance of 10 percent, but if you have then you get around 0.95

and that is also quite acceptable. If you have a 0.95 power factor and THD below 2 percent then it is acceptable to all the standard.

(Refer Slide Time: 09:39)

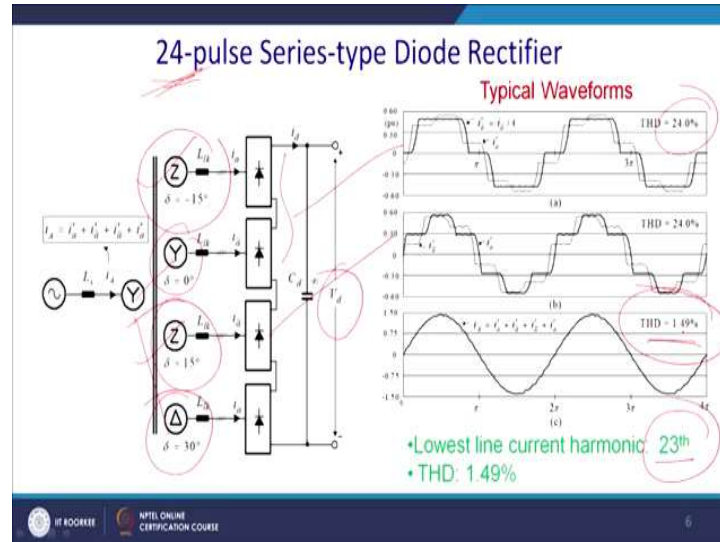

Same way we can extend our discussion to the 24-pulse converter and the lowest harmonic will be 23rd as you can eliminate the 11th and the, 5th, 7th, 11, 13, 17th, 19. So, next will be 23 and 25. But 25 also will not be present because your 5th harmonic is absent, you will get even 27<sup>th</sup>. But that will not be present as well because your third harmonic is absent. Ultimately you get the 29th harmonic. So, 23 and 29, these are two elementary number. So, these two harmonics will be present in the system.

Now in this case since this is a 24-pulse converter, you will have 4 such converter connected in series and ultimately you get a huge dc bus voltage and that may be required and we can feed it to the multi-level inverter. And, that is quite a requirement for a high-power application and thus this kind of topology fits well. You see there is one part of it you know this part and this part is nothing but your 12-pulse converter. So, you can have a star with respect to it. You can have a zero-phase shift and thereafter with respect to it you can have a 30-degree phase shift. So, there is a vector group that will operate. It is YD11.

Then these will have a special kind of construction because you generally have star and delta connections that is not challenging. But when you made an 18-pulse converter that require a YD11, that itself is a design that you will actually go with. So, this design is little

complex and for this reason we required to have an 18-degree phase shift or having a 15-degree phase shift. So, we required to have a special kind of transformer to be designed. You can have to some extent the manufacturing advantage because you will be using star-star and star-delta and this vector group is available to you commercially. But this is only two special vector group which you require to make in case of the 24-pulse converter.

But whereas, if you go back to the 18-pulse converter, you require to make these two special transformers which will give you the 20-degree phase shift. Thus, sometime you know it require more component count from this. From the manufacturing point of view, we do prefer the 24-pulse converter. Because you know it eliminates all the harmonics for the fundamental up to 23rd and the manufacturing is easy because you require to manufacture the special transformer of 15-degree phase shift and plus and minus 15-degree phase shift. Whereas in case of the 18-pulse converter 20-degree phase shift, these are the special transformer you require to make, but for both of the cases you require two special transformers.

These three transformers are rarely readily available to you and for this reason this has more popularity over the transformer required for 18-pulse converter. Because if the component of the costs of the manufacturing becomes same then the transformer required for 18-pulse converter may not be attractive at all. Hence, we may not go for 18-pulse converter operation because ultimately you get all those entities better. So, ultimately you have all the current, four current in this  $i'_a$ ,  $i'_{\bar{a}}$ ,  $i'_{\bar{a}}$  and  $i_a$  will form the primary current  $i_A$ .

So, this is the  $i'_{\bar{a}}$  and that has to be the  $\frac{i'_{\bar{a}}}{4}$  and this will have a THD of 23 or 24 percent. Similarly, this is the  $i'_a$  and this is the  $i'_{\bar{a}}$ . Ultimately all these 4 currents have been split. Upper two current is shown here and lower two current is been shown here. So, if you add up all those four currents and you get a THD it will be well below 2 percent. This actually satisfies all the conditions of your power quality and thus you do not have a problem of little under loading. So, you can see that we generally do not have a zero source impedance.

(Refer Slide Time: 15:53)

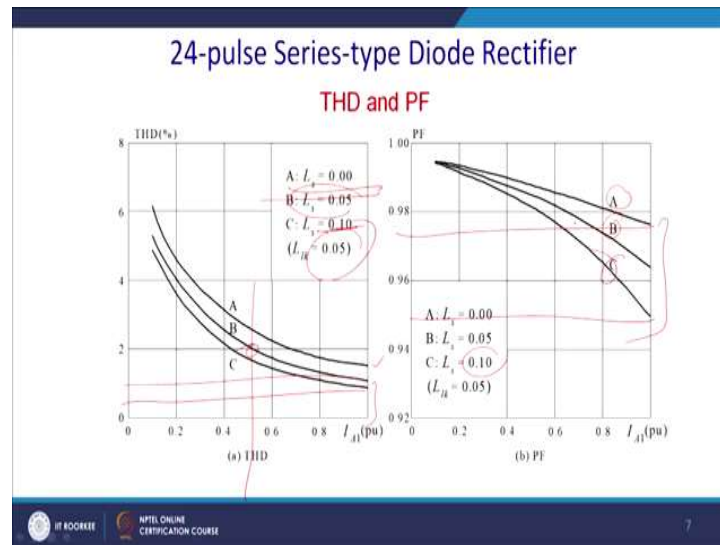

Considering that class 'A' is an ideal case generally, Class 'B' considering that 5 percent per unit and this will have a droop like this and the THD is around less than 2 percent. If you have a little more source inductance, then you will get THD for below 2 percent maybe 1 percent as well.

And even in a light load like 50 percent light load, you can see that consider this is a typical middle man in the road 'B' that is 5 percent source inductance at half load. You can see till that this is a curve 'B' and it is actually crossing this 0.2 percent THD. So, at up below of half of the load this 24-pulse converter for 5 percent source inductance that is quite feasible and practically it is in the consideration and with 5 percent leakage reactance, you can get easily 2 percent THD.

Similarly, you can see that your power factor also been improved. So, you have A, B, C, these three curves and you can see that 'A' gives you generally little less than 98 percent without any source inductance. Generally, we are interested about 'B'. 'B' is well above 95 percent in the full loading and if your loading is decreases then definitely power factor gets better.

So, now, you have no problem and 'C' can reach around .93. But it is generally 'C' curve and it requires huge source inductance and it is generally not externally connected. For this reason, 'B' curve is matching at all the limits which we were discussing the limiting conditions for the THD and power factor. It can consider all the limits.

(Refer Slide Time: 18:33)

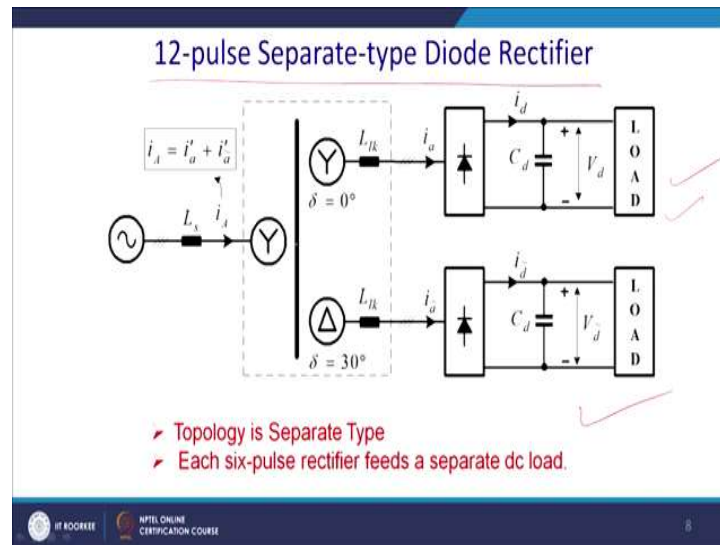

Now, till now we have seen the series operation of the converter. So, series operation of the converter and it get reflected. Ultimately, it may be feeding the multi-level inverter for the different kind of speed drive. But 12 pulse separate type diode bridge rectifier anyway, this one  $i_{\bar{a}}$  equal to that. We can have this parallel connection also. It can fit one adjustable speed drive, it can fit another adjustable speed drive, but then there will be a problem because loading may differ and thus proper cancellations in primary side may not be feasible.

But assuming that they are having same kind of loading, you are required to balance somehow. Assuming that they have a same kind of loading, then you can also get cancelled your 5th and 7th and ultimately you are left with the higher harmonic more than 5th and 7 that is 11 and 13.

So, you can have a same entity, but you do not connect them in series. So, this is a topology separate type 6-pulse converter rectifier feeds a separate dc load, but there is only one risk involved. If the loading is different then proper cancellation of the 5th and 7th is not possible. Now same way, we can have. This is something where Siemens comes into the picture. You can Google or you can search the brochure of this Siemens drives. It is called ruby drive. They have also changed the new nomenclatures.



(Refer Slide Time: 20:33)

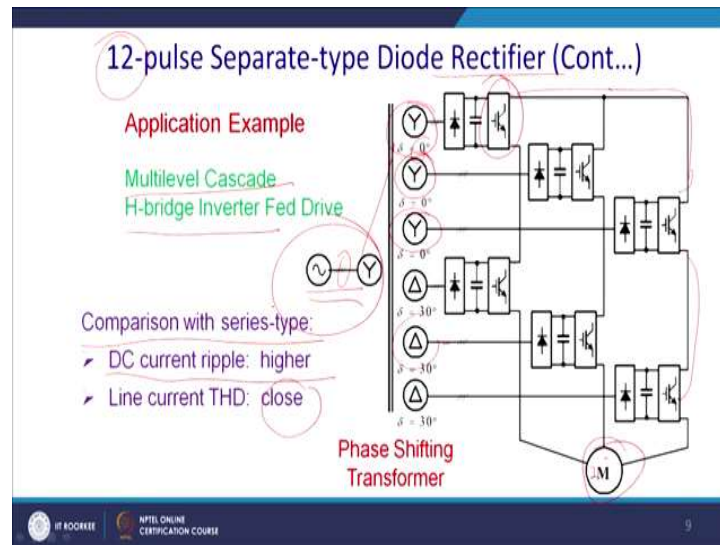

So, that was for the 24-pulse, but I have derived for the 12-pulse separate diode bridge rectifier type to simplify the structures of the system. So, you can see that this is a star, this is star and thus you can have one. Thus, you can feed it to this converter. You can see that it goes from here. Thereafter, it goes to here then there is another star. So, there is no phase shift, this one and this one and then you feed it here and thus you can have this voltage, this voltage and this voltage are connected in series.

And here this one is your phase 'a'. Then what you have? This one is in same phase, but this one will be a 30-degree phase shifted. So, thus there will be a reflection of this drives part here. Similarly, this is the star ultimately you will feed it here. So, it takes this voltage from here and this star and this star will add up. Thereafter, this voltage will be taking up a delta and ultimately will feed here. Similarly, this voltage and this voltage will star up and will have a feed there.

So, in that way this 3-phase has been generated by cascading the 12-pulse and ultimately it will cancel out the effective harmonic and it will give you a good quality drive and this is generally the way of feeding a multi-level inverter. These all are cascade multi-level inverter topology. These are all the inverter block. This is one inverter block, one another inverter block. They have put them in series to build up the voltage. In that way you can use them. This is called multilevel cascade H-bridge inverter fed drive. On 24 versions of these Siemens has got the patent. Just for the sake of simplicity, I am showing the 12

version of it and it has huge advantage. Check see the advantages. Ultimately you get a very good power factor in here as well as the THD.

Apart from that you are not using any special kind of transformer because if you want to have a 18-degree phase shift or if you want a twenty degree phase shift, then you require to have a special constructions for it and thus it requires a customizations in drives. Hence if you do the customizations like you know if you take a shirt which does not commercially available, you require to pay more. Similarly, you require to have a special kind of transformer to be designed and if you do not have a bulk demand, then cost will go up for those kinds of entity and commercially viability here is a question mark then.

But here you are not using any special kind of transformer. Still you can achieve a very good THD. Students, I request you to simulate this circuit. It is very easy to simulate and ultimately see that what kind of THD you are getting. I am considering that this is an induction machine. But we can compare with this series type these configurations and generally what happen, we will observe that the dc current ripple will be little higher and the line current THD will be close to this in case of your series connected THD.

(Refer Slide Time: 25:35)

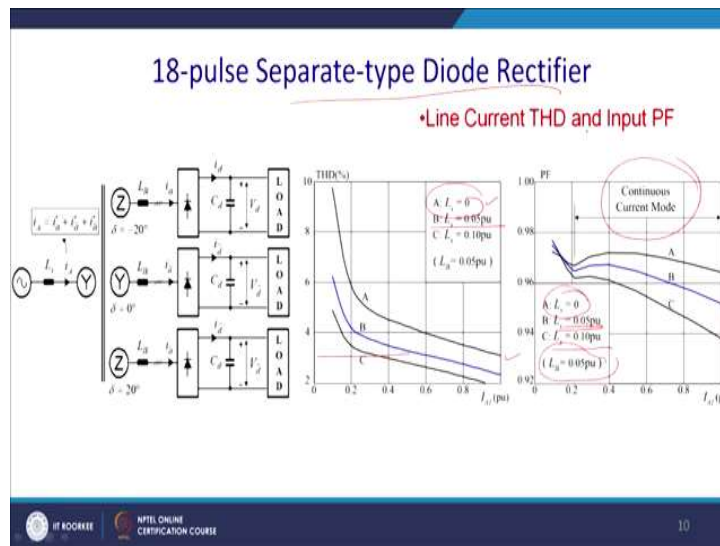

So, this is the analysis of it for the 18-pulse converter and for the separate rectifier. So, you can see that this gives you this big graph for the 18. Here for the half load, you have a THD close to 3 percent. Otherwise it is same you know actually this is the case. We

generally do not consider it because we will have some kind of leakage reactance as well as some kind of source reactance.

So, this will be the case for the zero-source impedance. Thereafter, if you have 0.5 per unit, this is the 'B' curve and the blue curve which can be referred into them or this comes into the picture for most practical situations. You can see that. You can get little more than 3 percent. Same way if  $L_s$  is equal to '0', then you can have 0.05 percent per unit and  $L_s$  equal to 0.1 per unit and in that way you can get  $L_k$  equal to 0.05 per unit and ultimately you can get A, B, C, all those curve.

Please mind it, till this point this current is in continuous conduction mode. But if you have a discontinuous conduction mode, your power factor is going to be high definitely, but THD also will be high for your displacement power factor.

(Refer Slide Time: 27:37)

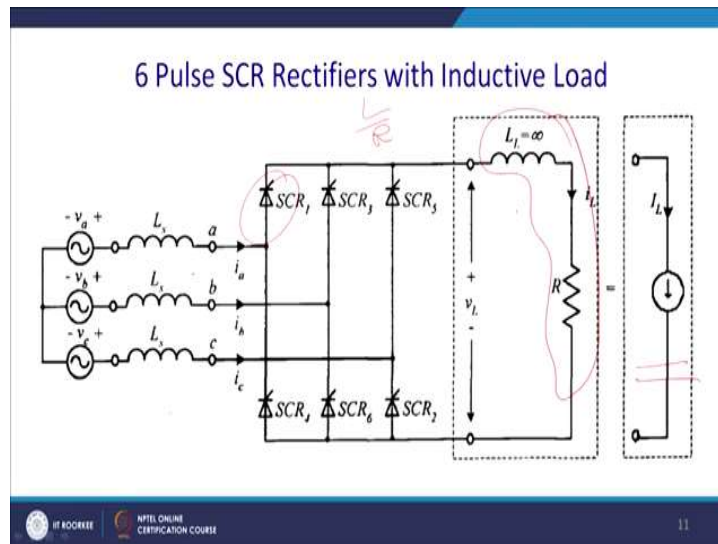

Now, 6-pulse converter for the inductive load and this is something we have discussed and these you can model as a current source because  $L$  is very high, but practically speaking nothing is infinite. But let us say,  $\frac{L}{R}$  ratio. If it is 10 times more than 10 millisecond and 100 millisecond then we can take them because the dropping will be so less that we can consider this entity is essentially a current source. Then what will happen? You will have a constant current source and if you take this thyristor. Then what will happen?

(Refer Slide Time: 28:39)

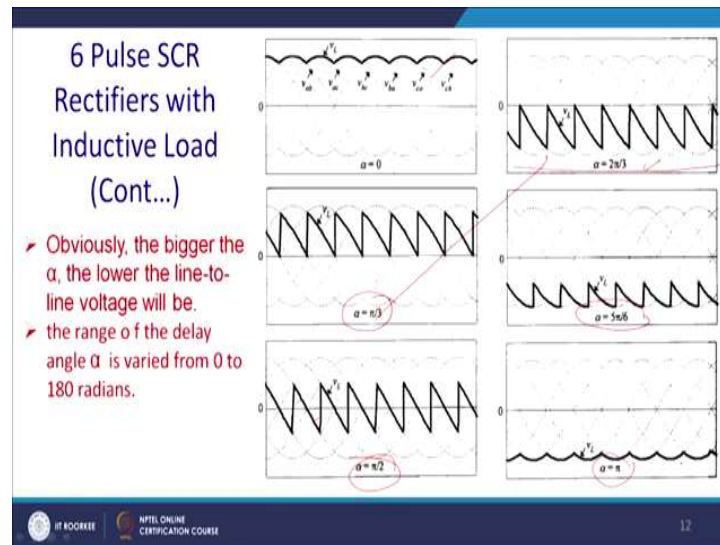

Ultimately this is your load voltage for alpha equal to '0' for first basics and this is the case for alpha equal to 30 degree. Still you have a continuous conduction mode and this is the alpha equal to 90 degree where you have a zero-load voltage. Because you can see that positive area and the negative area are same and thus you are essentially not taking any power from this grid side. When you want to have a conversion, you want to send back power to the grid. We are supposed to do the same thing in case of your PWM rectifier.

Then you will have this kind of waveform. It is same just it is a mirror image of 60 degree. Same way you can get the mirror image of it for alpha equal to 30 degree which has not been drawn and this is alpha equal to  $\pi$  in that case. This is just mirror image of this one with respect to 'x' axis and ultimately you get this figure.

(Refer Slide Time: 30:09)

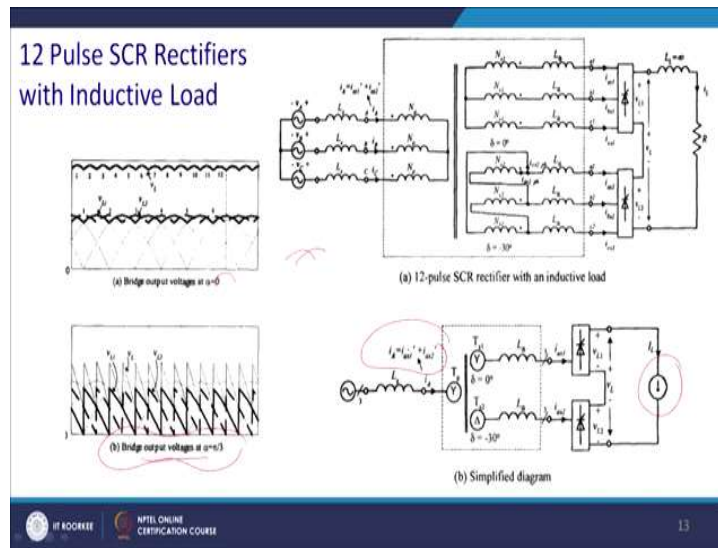

And that is quite common which you have studied in the power electronics courses. Now what happens? You have a 12-pulse converter and you are feeding highly inductive load. Then what will happen? You will see that this is for alpha equal to 30-degree phase shifted and by the 30 degree both and this is for alpha equal to '0'. Ultimately in a voltage they will all have a phase shift.

So, ripple will cancel out and ultimately instead of a 6 pulse, you get a 12 pulse in the primary volt in the output voltage and this will be alpha equal to  $\frac{\pi}{3}$  and this will be the output voltage pattern for highly inductive load. So, similarly if you put them in series with that alpha will be equal to 30 degree. This is the simplified diagram and ultimately you will get this current profile  $i_{as1}$  and  $i_{as2}$ .

(Refer Slide Time: 31:27)

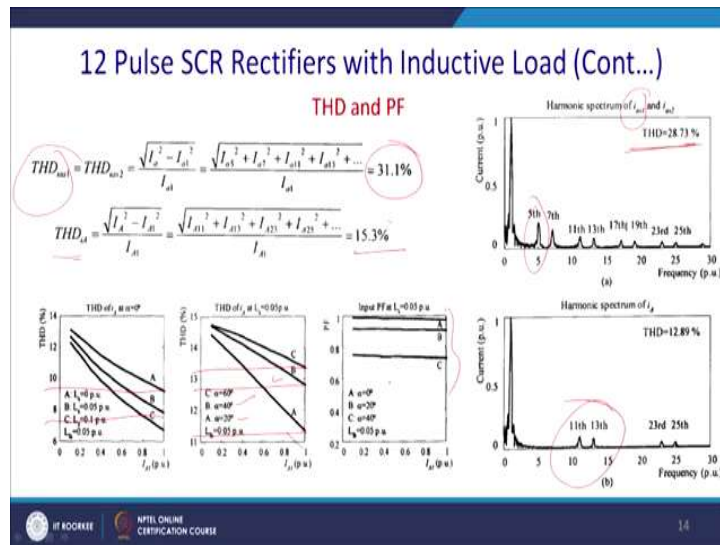

Thus, what you can expect? In case of the highly inductive load for the 12-pulse converter individual  $i_{as1}$  and  $i_{as2}$  (since it is a square waveform) will be reflected into the primary site. So, you can expect that THD will be as high as 30 percent. It is 28.73 and you will have the component of the 5th harmonic, 7th harmonic, 11th harmonic, 13th harmonic and so, on. But of course, you will find that, it is highly inductive load, once you couple them for the 12-pulse and 5<sup>th</sup>, 7<sup>th</sup> will be eliminated and ultimately you are left with 11th and 13th, 23rd and 25th.

So, generally you know, you can see that if you add up the THD portion of it, you will get as high as THD of 31 percent. But, if you want that THD, that should be around 15 percent for the 12-pulse converter. Same treatment, what we do alpha equal to '0'. You can find that THD is close to the 8 to 9 percent for zero source inductance. But for practical cases, you will have this (b) with the 5% source inductance and that will be close to the 7 percent.

If you increase the alpha, alpha triggering angle, what you can see that THD generally increases for alpha 60 degree you know this is a case. Thereafter alpha 40 degree. This is the case and alpha 20 degree, this is the case. This is a drooping characteristic and you get around 11 percent THD. For (b) alpha 40-degree you get around 13 percent THD and for alpha 60 degree. You get around 13.5 percent THD. Same way power factor is also almost same in case of the (a). So, it will be close to one and does not vary as such. All those

values are close to constant. Power factor: some of it comes from the displacement power factor. Almost that value is been continued.

(Refer Slide Time: 34:11)

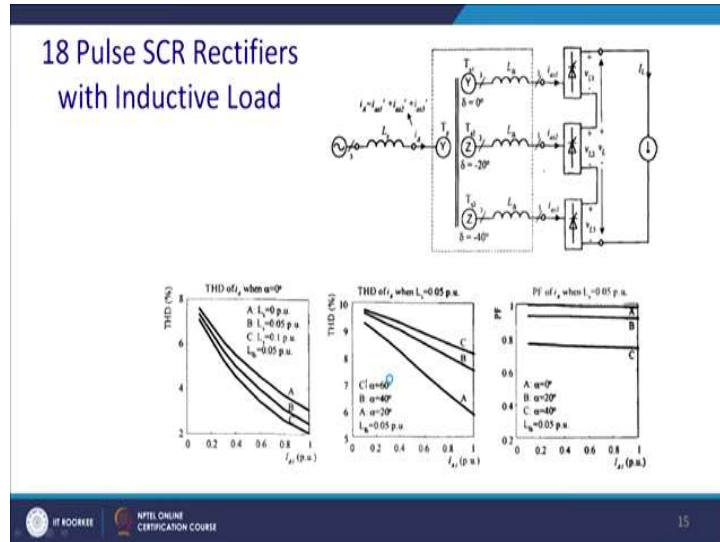

I shall continue with the 18-pulse converter from next class.

Thank you for your attention.