

Principles of Engineering System Design
Dr. T. Asokan
Department of Engineering Design
Indian Institute of Technology, Madras

Lecture - 10
Functional Decomposition

Dear friends, in the last class we discussed about the functional decomposition of systems and we discussed about one method called Hatley–Pirbhai template or HP template and how to use this HP template for decompositions of functions and then getting a functional architecture based on the hierarchy of the functions.

As mentioned, there is one more method I would like to discuss today and this method is known as IDEF0. Basically, we use a template called IDEF0 and using this template we decompose the functions and with the sub functions and then we see these sub functions we create a hierarchical function structure. IDEF0 is basically a graphical methods where we identify the functions and their inter relationships and all the control signals everything we represented using a graphical method and create graphical sketches of these functions in order to identify the sub functions.

(Refer Slide Time: 01:14)

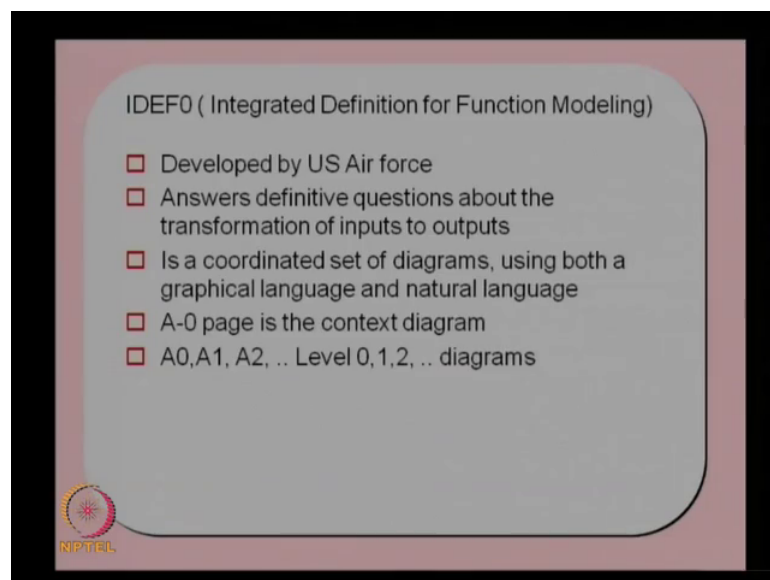

Basically, this method known as Integrated Definition for Function Modelling or in short IDEF0, 0 was added I mean is a first initial chart that is why it is known as IDEF0, it is a integrated definition for function modelling. This was developed by US Air Force in

order to develop some of the aircraft systems or defence systems and to identify the functions needed. So, this actually answers definitive questions about the transformation of inputs to outputs. Basically, every function can be considered as a relationship between input and output and there therefore, this method answers the question about transformation of inputs to outputs. So, what actually happens to the inputs and what are the transformation the input is going through in order to get the outputs and this can actually be clearly answered using the IDEF0 chart and it is a coordinated set of diagrams using both the graphical language and natural language.

So, there are there is a basically a graphical representation. So, we use some of the graphical language as well as the natural language to describe the functions. Here, we use different diagrams A hyphen 0 or A0 page is the context diagram. So, basically this diagram gives the overall function of the products or the system and gives the inputs outputs and the control signals as well as the mechanisms through which the system operates. So, A hyphen 0 is the context diagram and then we use different diagrams like A0, A1, A2 which are the level 0, 1, 2 diagrams. So, and this is actually goes on till we reach the final or the last sub functions which we do not need to decompose further.

So, the number of levels are not fixed, but actually depends on the systems and it is functions.

(Refer Slide Time: 03:14)

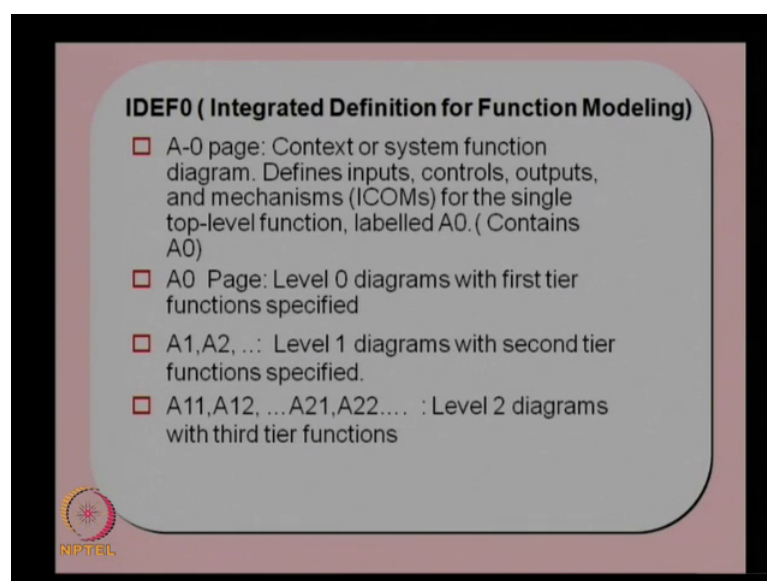

So, as I mentioned there are different levels of diagrams. We can actually show it as the A-0 page that is the context or system function diagram; it defines the inputs, controls, outputs and mechanisms or known as ICOMs. So, in this diagram we represent all the inputs, the controls, outputs and mechanisms for the single top level function and this top level function is labelled as A0. So, A0 is a function in the context diagram A hyphen 0 and here we represent all the inputs, controls, outputs and mechanisms.

Then we have the A0 page which is the A0 function be composed into it is level 1 functions. So, level 0 diagrams, A0 is the level 0 diagram with first tier functions specified. When A0 diagram we specify the first tier functions and they will be referred as A1, A2, A3 and so on, as the number of functions. So, A hyphen 0 or the context diagram contains the function A0 and A0 diagram or the level 0 diagram contains the functions level 1 functions A1, A2, A3 etcetera and so on, it goes.

The A1 diagram A1, A2 etcetera are the level 1 diagrams with second tier functions specified and A11, A12, A21, A22 etcetera are the level 2 diagram with third tier functions and so on and it is go on till we reach the final decomposition stage.

So, here as mentioned there are context diagram and then A0, A1, A2, A11, A12 and A21, A22 diagrams, level 1, level 0, level 1 and level 2 diagrams.

(Refer Slide Time: 40:50)

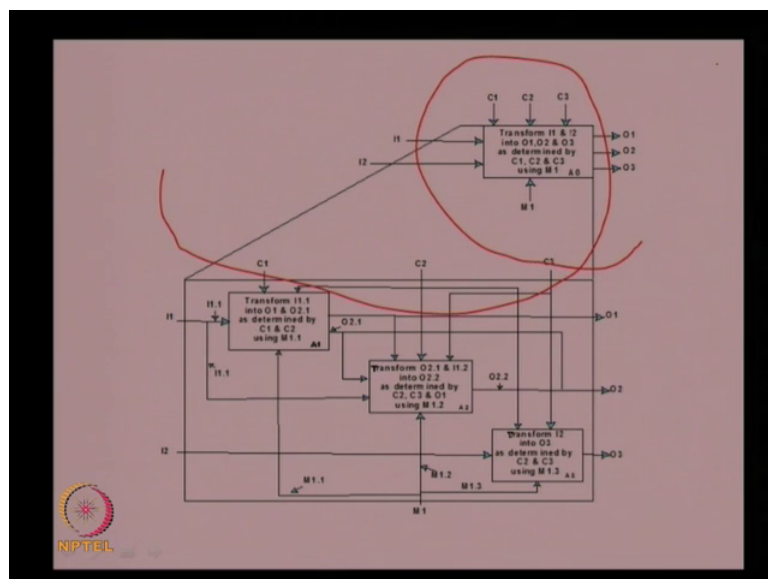

So, this is actually shown over here. So, this is the diagram this is known as A0. So, this is the A0 diagram here and then you have the inputs, outputs and control diagrams. So, here you can see the inputs I1, I2 are the inputs to this top level function or the A0 function and then C1, C2, C3 are the controlled inputs and then O1, O2, O3 are the outputs and then you have here the mechanism through which this transformation takes place. So, that is the top level context diagram A hyphen 0, it is a context diagram and the same diagram can be expanded to the next level which is known as the A0 diagram where you will show the A1 functioning, A2 functioning and A3 functioning.

So, this is shown as separately in more detail with explanation. So, you can see here this is the first level A0 diagram with I1, I2 as the input, C1, C2, C3 as the controlled inputs, O1, O2, O3 as the outputs and control inputs, sorry, this is the control input and this the output and this is the mechanism through which it is converting the I1, I2 into O1, O2, O3 as determined by C1, C2 and C3. So, that is the top level function A0 and then this A0 function is divided into its sub functions in the A0 diagram or the level 1 diagram.

So, here we show the input I1 and C1, which is acting on the function A1 which actually converts, transforms input 1 to output 1 and output 2.1 as determined by C1 and C2, using M1.1. So, this is the M1.1 mechanism and then here you can see the transform this is another function, this is A1 function, this is A2 function and this is A3 function. So, the main A0 function is divided into or decomposed into 3 functions A1, A2 and A3 and all the inputs and the controls are shown separately for this one. So, here you can see I1 is an input to A1, I2 is an input to A3, but I1 is going again to A2 also.

Similarly, C1 is a controlled input to A1, C2 is a controlled input to A2 and C3 is a controlled input to A3 and the outputs are O1 is coming from A1, O2 is coming from A2 and O3 is coming from A3. So, this is just a typical representation, it is not necessary that O1 should come from A1 or O2 should come from A2. It actually depends on the function, depending on the function the output may come from function or the output may come from different functions, but the beauty of this representation is that we can actually show all the inputs and the controls, as well as the outputs separately and their interaction between the sub functions.

As you can see here the output from A1 which is the output O1 this is actually going to A2 as a control input to this and then this is going to this as a another input also O2.1 is

going to as an input. So, similarly the output is O2.2, which is going from here and that is again going back to that is coming from A1 also. So, like this you can have different interactions between these controls and outputs within the function. So, this can be represented using the IDEF0 diagram.

(Refer Slide Time: 08:33)

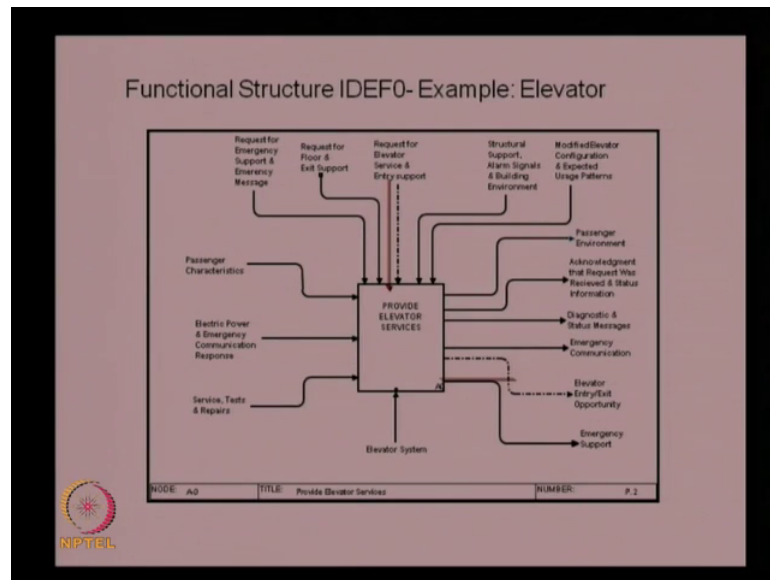

So, take an example to show the functional decomposition you will see IDEF0 diagram. So, here we take the example of elevator which we discussed earlier also. Now, you are familiar with the elevator system and its requirements. So, we will actually take this same case study and then use that one for explaining the functional decomposition using IDEF0 diagram.

As you can see, this is the context diagram or you can say this A0 is the top level function which is provide elevator services and all others are inputs and control signals and outputs and you have the mechanism as the elevator system as the mechanical system which actually provides this service.

(Refer Slide Time: 09:14)

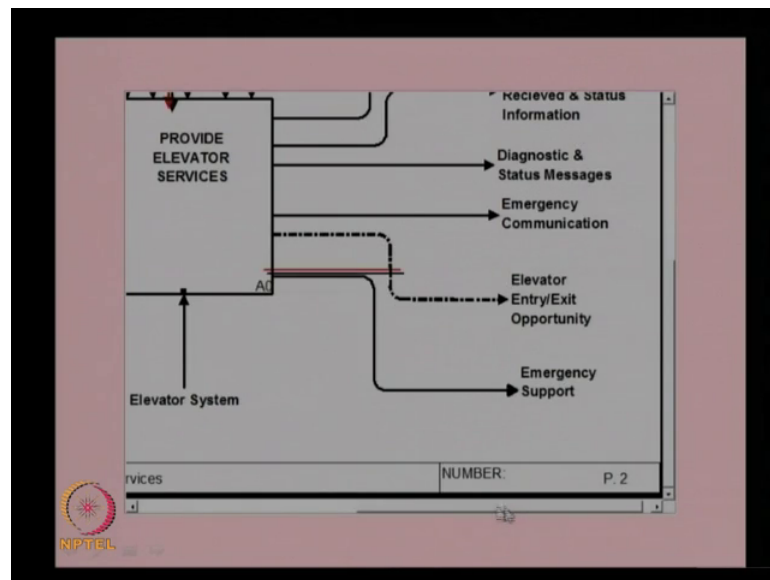

So, there are different inputs. You can show it in a better way in this diagram. So, you can see here this is the context diagram.

(Refer Slide Time: 09:19)

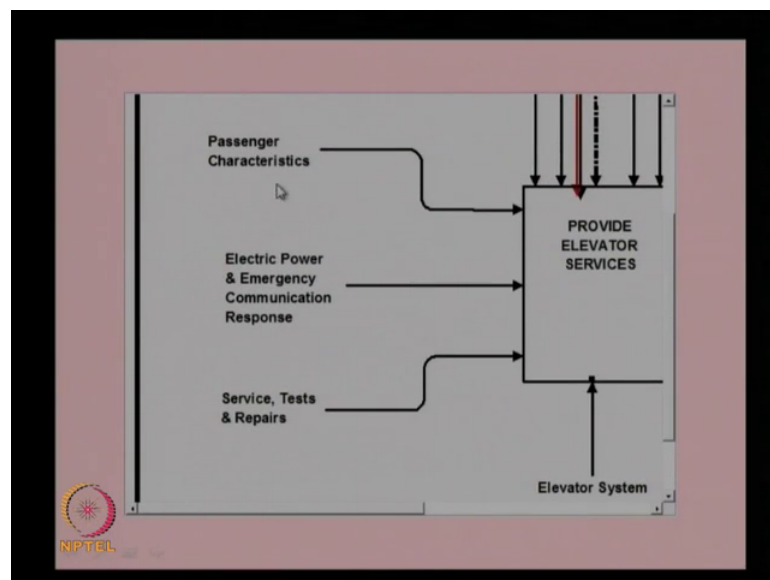

So, these are the inputs; the passenger characteristics are inputs, electric power and emergency communication response are the input, the service tests and repairs are the inputs here.

(Refer Slide Time: 09:31)

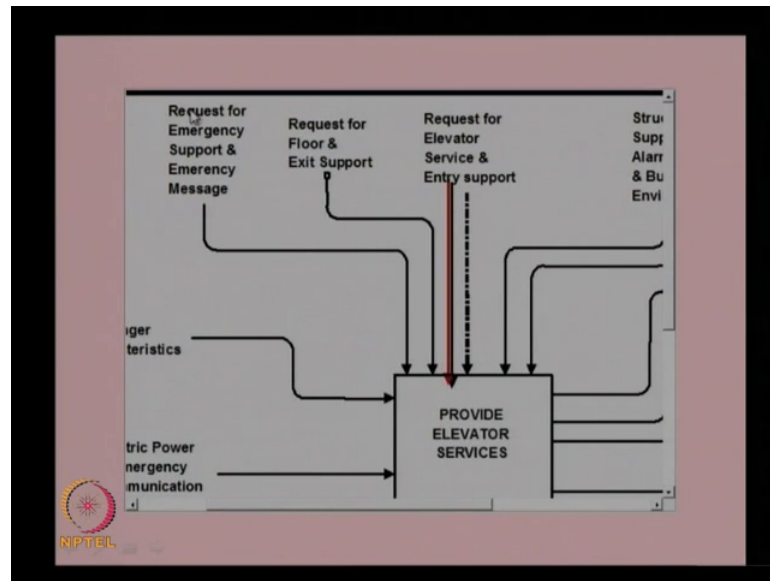

And here you have other inputs like the request for emergency support and emergency message, request for floor and exit support, request for elevator service and entry supports.

(Refer Slide Time: 09:43)

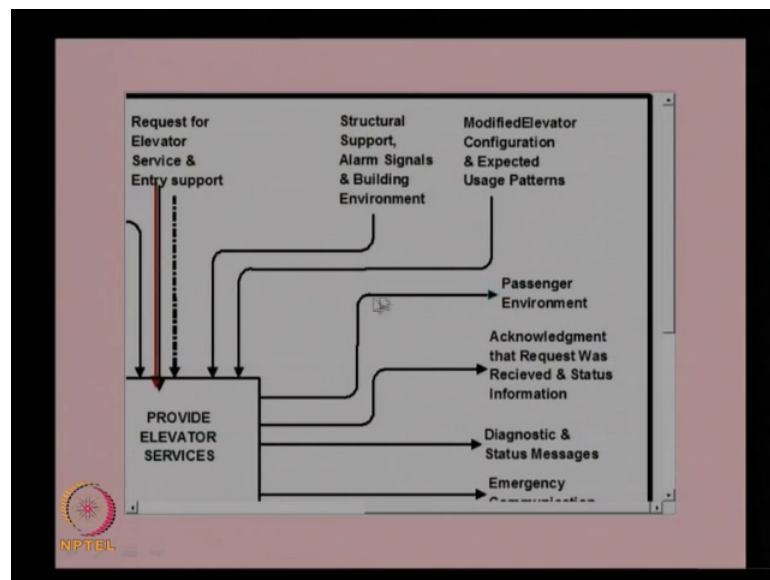

Similarly, the structural support, alarm signals and building environment and modified elevator configuration and expected usage patterns. This is basically from the patterns that also will be given as an input to the system. So, these are all the inputs going to the system and the output coming from the system are the passenger environment, what is

the status of passengers in this particular scenario, then the acknowledgement that request was received and status information; basically, as an output the present status of the request are provided by the customer, so, what is the status and an acknowledgement and diagnostic and status messages whether any problems are there or any trouble shooting is to be done or servicing to be done, that kind of diagnostic messages given as output and emergency communication from the elevator to the external system to the police or the fire service or to the building administrator. So, that will be given as emergency communication then elevator entry exit opportunity provided by the system.

(Refer Slide Time: 10:46)

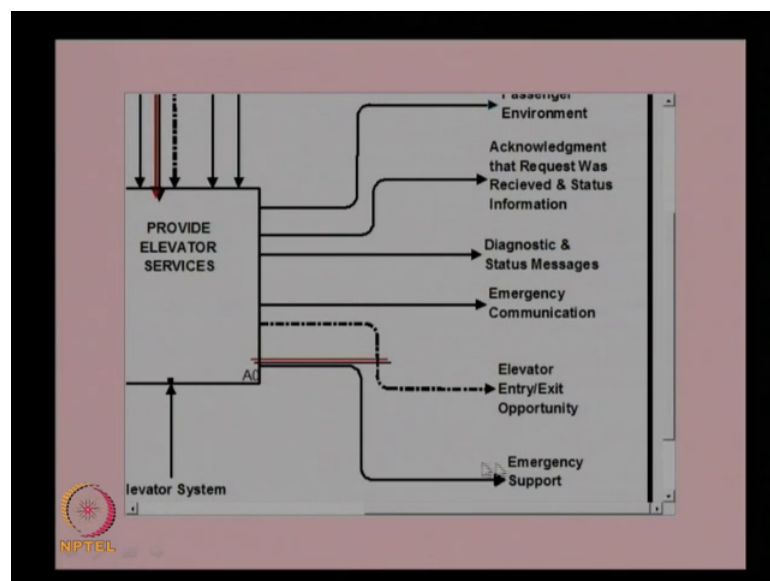

And then emergency support and emergency situations like supporting the passengers in the case of emergency by providing; opening the doors or going to the next level of wherever the access is available. So, these are the outputs coming from the system. So, as we can see here elevator system is the main mechanical system which actually provides elevator services. So, here the elevator system is converting all these inputs to outputs and giving it as outputs.

You must have noticed a red line over here and a dotted line, so this is basically to for another purpose. This diagram can be used for tracing any input and finding out what actually happens to this input or what kind of conversion taking place these inputs or we will see that later, once we complete the discussion about the IDEF0 diagram and one of the application for IDEF0 diagram I will explain this at a later stage.

So, this is the context diagram which provided the overall main function of the elevator system as well as the inputs and outputs.

So, the next task is basically to divide this function into sub function. So, the context diagram will provide you the top level function A0 and the A0 diagram or the level one diagram will provide you the sub functions A1, A2, A3 and see how to show that using IDEF0 diagram.

(Refer Slide Time: 12:09)

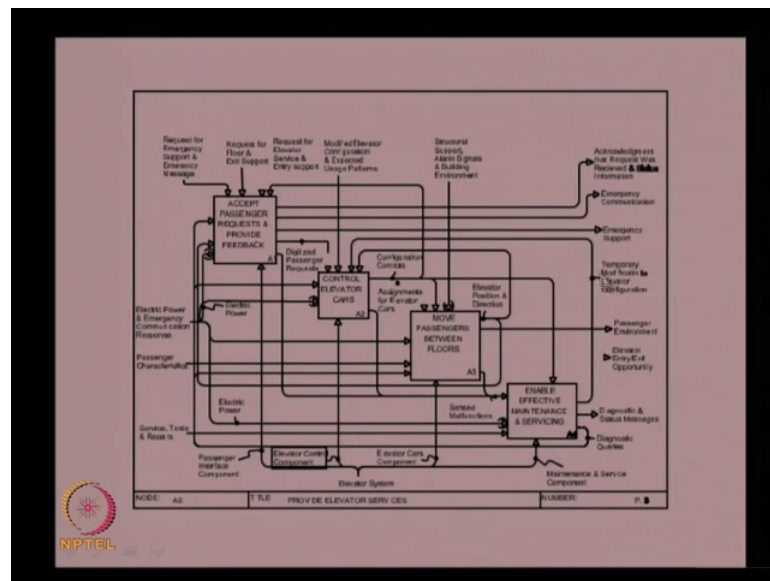

So, this looks difficult to read, but I will show you another diagram where other details are given. So, overall picture is shown here. So, you can see that this is the accept passenger request and provide feedback as one function, control elevator cars as another function, move passenger between floors as another function and enable effective maintenance servicing as another function.

So, in A0 diagram that is the level 1 diagram we divide the, decompose the top level function or A0 function into A1, A2, A3 and A4. Similarly, with identify the inputs and outputs, inputs to the A1 function and the output going from the A1 function and whether these outputs are used by the A2 function or they are going directly to outside the system. So, all those can be represented using this diagram. So, here we write down the signals, the input signals as well as the output signals and is represented if there is any input, output coming from the system represented separately with the descriptions.

(Refer Slide Time: 13:22)

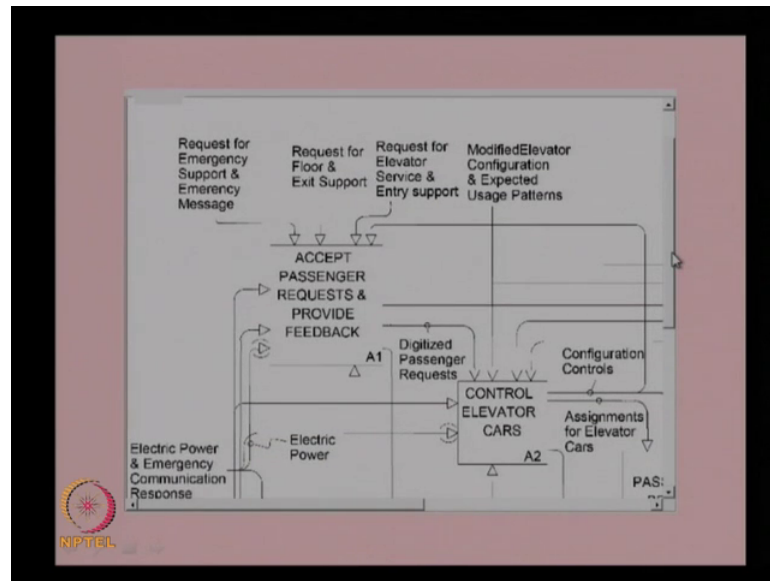

So, to go into the details as you can see here, this is basically the decomposition A1, A2, A3, A4. Basically, we are taking the A0 function and dividing them to A1, A2, A3 and A4 as shown here.

(Refer Slide Time: 13:35)

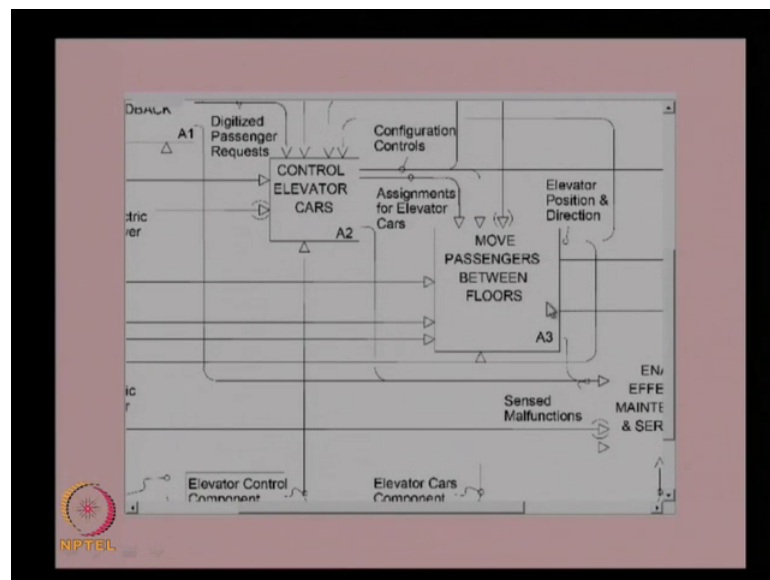

As you can see here, so this is the first one A1 function, accept passenger request and provide feedback, that is the first function of decomposition A0 and the inputs are request for emergency support and emergency message, request for floor and exit support and request for elevator service and entry support and these are the main inputs

coming from the passengers. And other inputs are electric power and emergency communication response that will be coming to this function. So, these are the inputs coming to this and from here we will be getting output, many outputs from here and some of the outputs will be going to function A2.

(Refer Slide Time: 14:15)

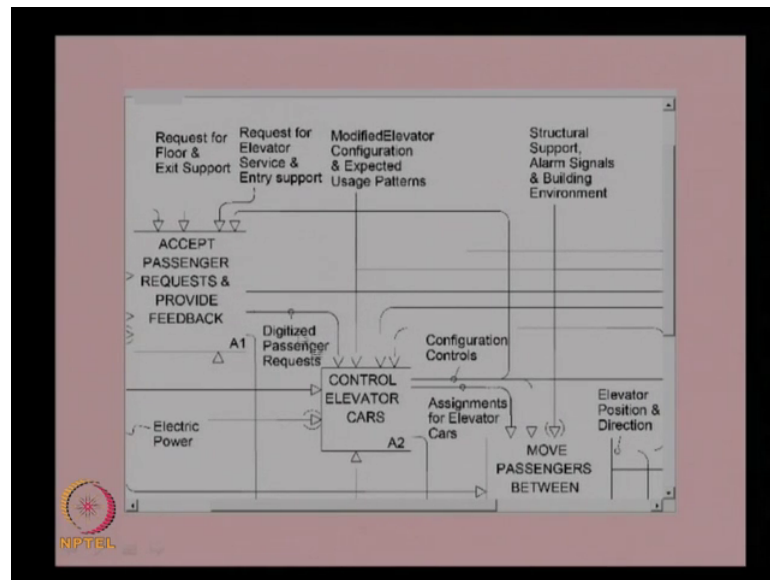

As you can see here, one of the output from this function is digitized passenger request. So, here the passenger request is digitized and send to the next function called control elevator cars. So, this is the function A2 and from here you can see there are other inputs also coming like modified elevator configuration and expected usage pattern. We discussed about these inputs, the context diagram. So, that input is coming to control elevator cars.

(Refer Slide Time: 14:45)

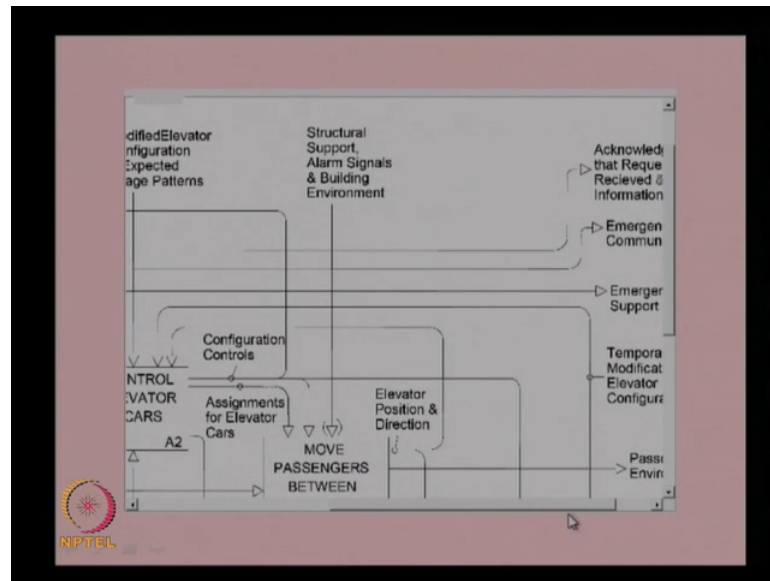

And other inputs are coming from other sources, from other functions also inputs will be coming to this function and if you process all this inputs and give the output like configuration controls and assignments of elevator cars. That is one of the important outputs from this function assignment for elevator car. So, which car should go to which floor and where it is always information should be processed and the assignments will be send to this one.

And that will go to the third function called move passengers between floors. So, that is the A3 function. So, here the one input is basically the elevator car assignment, the other one is the building and environment depending on the structural support alarm signals and other inputs will be provided and that input also will be processed along with the configuration control inputs will be processed here, plus you will be getting other inputs from here like a electric power emergency communication and passenger characteristics. So, all these will be processed and this function called the move passengers between floors.

(Refer Slide Time: 15:47)

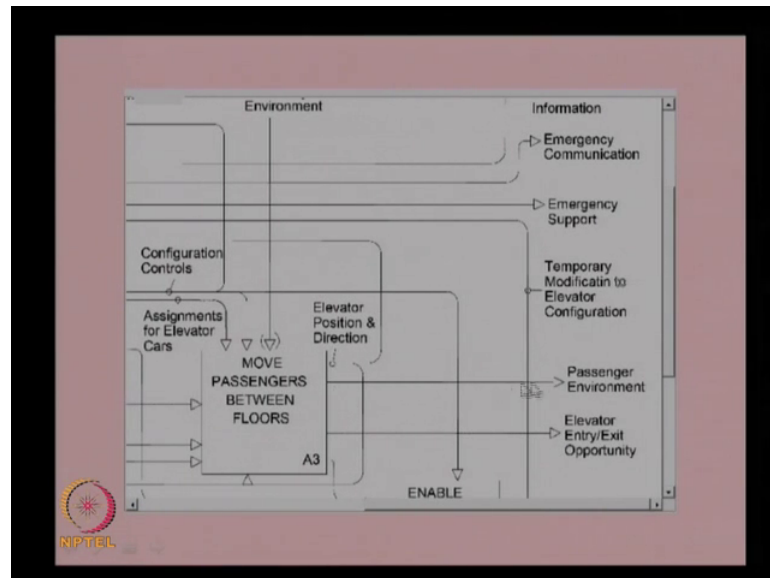

And then we will be having the passenger environment as the output and elevator entry exit opportunity is output from the A3 level function. So, this is A3 level function.

(Refer Slide Time: 16:00)

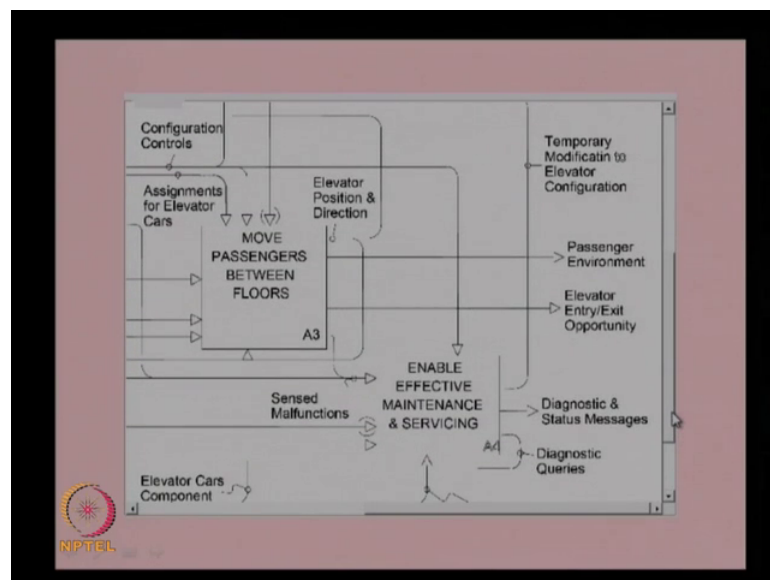

And then the last function is basically to enable effective maintenance of and servicing of the system. So, in order to provide the elevator services we need to have the effective maintenance servicing also. So, the inputs from various sources will be coming about the status of all the functions and other controls will be coming here and the sensed malfunctions also will be coming as input and based on this function will process the

diagnostic and status messages and that will be send to as an output from here and this queries also will be used by other functions in order to execute their functions. So, like this you can see the main function A0 is divided into A1 function, A2 function, A3 and A4 function, 4 sub functions and the inputs and controls to these functions are shown clearly in the A0 diagram or the level 1 diagram.

So, this first level is basically to with the decomposition of the main function into the top level or the top tier level 1 functions and then now this level 1 function each function in the level 1 need to be decomposed further to it is sub component or the sub functions and this is done in the level 2 diagram or A1 diagram. In A1 diagram we use our A1, our A2, A3 diagram; basically, A1 diagram will show the decomposition of A1 function, A2 diagram will show the decomposition of A2 function and A3 will show the decomposition of A3 functions. So, this is shown here.

(Refer Slide Time: 17:30)

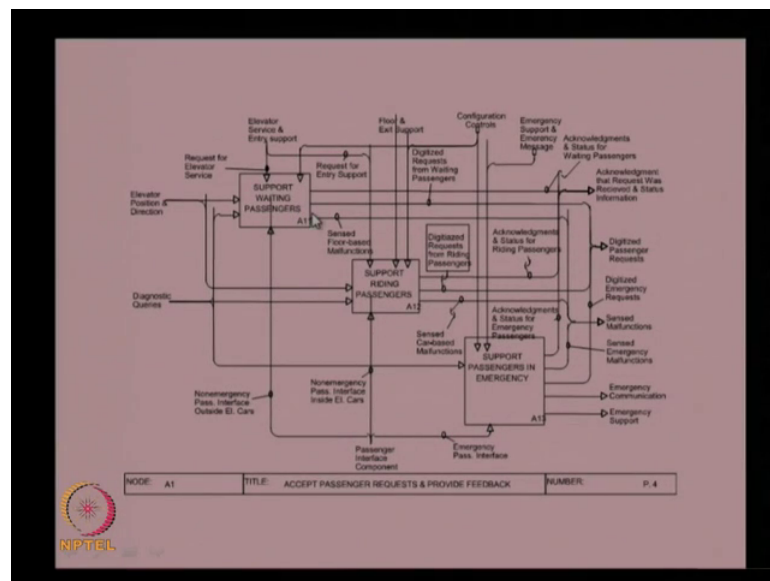

So, this is the A11 function, 11 is missing here. This is basically A11 function, this is A12 function and this is A13 function. So, in order to provide service to the waiting passengers, there are 3 functions you need to be there; one is that support waiting passengers, support riding passengers and support passengers in emergency. So, this the provide service to the passengers that is the A1 function is divided in to 3 sub functions like support waiting passengers, support riding passengers and support emergency passengers in emergency.

Then we will see how these you can see this is the diagram A1 diagram, which is accept passengers requests and provide feedback which is the main function and that is divided in to 3 functions over here. We will see the details of the input and output for this.

(Refer Slide Time: 18:22)

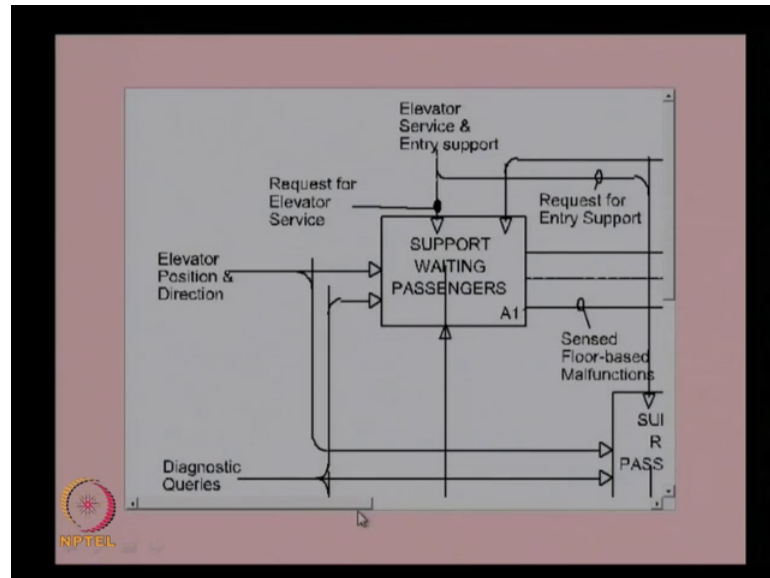

So, as you can see here this the A11 function. A11 function is the support waiting passengers. So, you can see here the inputs are request for elevator service and entry support and the elevator position and direction, these are the inputs and of course, the diagnostic queries coming from the maintenance function is also coming here. So, based on these this will provide the information to waiting passengers.

(Refer Slide Time: 18:53)

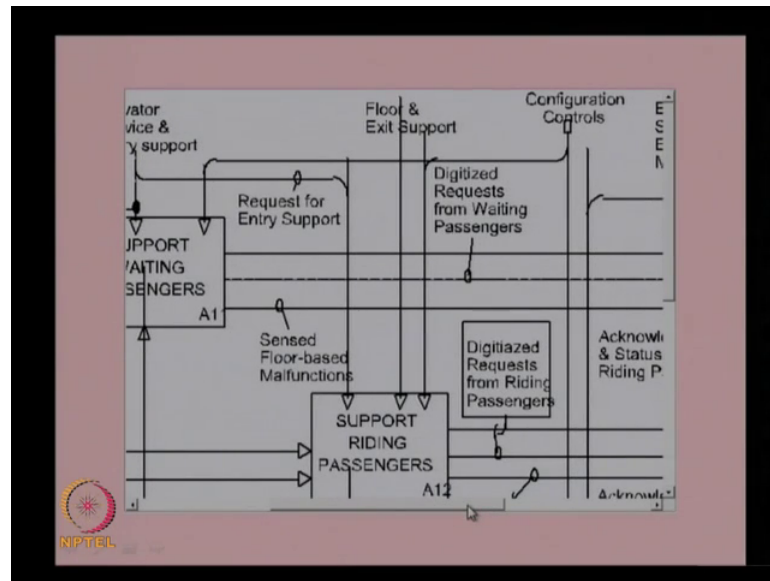

Basically, the waiting passengers need to know, where the elevator is and where it is moving, what is the status of the elevator? Whether it is in a working condition or it is in the service mode or it is under the breakdown or it is going to serve the passengers. So, that information need to be processed here and given as an output to the passengers.

(Refer Slide Time: 19:15)

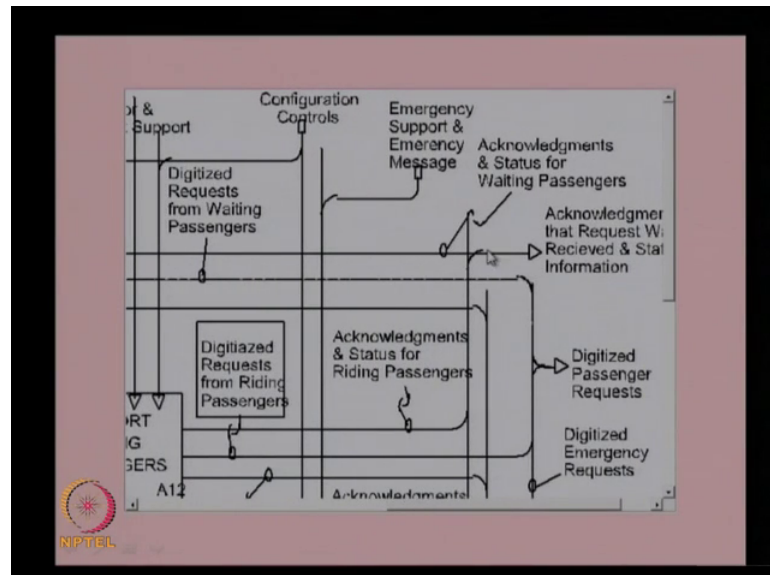

So, you can see here the output will be this is the output acknowledgement that request was received and status information. This will be given as an output from this particular function. So, acknowledgement and status for waiting passengers as the output from the

function A11 which is support waiting passengers. So, similarly we need to have support for the riding passengers also. So, in case of there is any malfunction you can take that is also an output from here. The sensed malfunction will be going to the service and maintenance function or it is going as an output from here and it will go to sensed malfunction as a output from these particular block that is from the A1 block and it will go to the A4 function which we discussed in the previous slide.

(Refer Slide Time: 20:02)

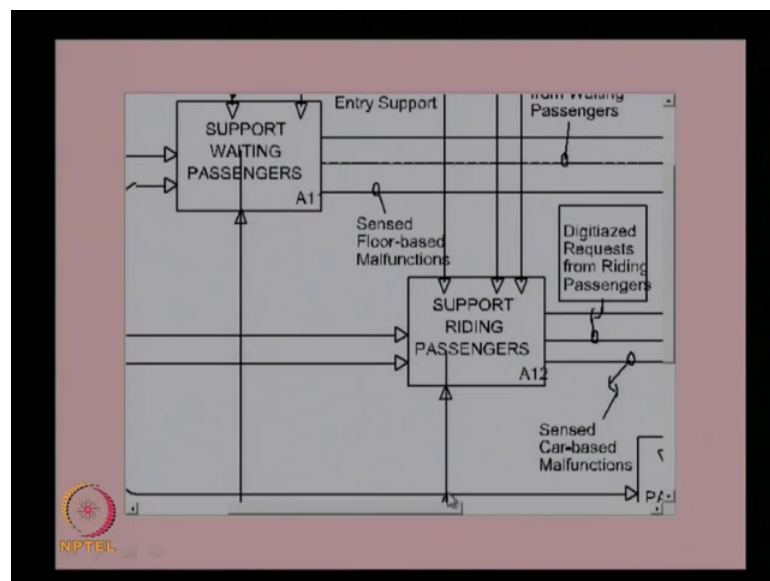

So, next one is support riding passengers. So, riding passengers the information are basically the inputs are elevator service and entry support input and floor and exit support and digitized request from waiting passengers. So, that is the waiting as well as yeah waiting passengers also will be also going as a input to the elevator. Apart from supporting the riding passengers it has to take care of the input request coming from the waiting passengers also. So, support riding passengers it is also is a input.

And other inputs are like elevator position and direction and diagnostic queries are the inputs. So, it will process these inputs and then provide the output like digitized request from riding passengers. So, the riding passengers will be giving some commands or giving input and based on the little process the requests and give the digitized requests and give to the control as output to the control elevator car function.

(Refer Slide Time: 20:55)

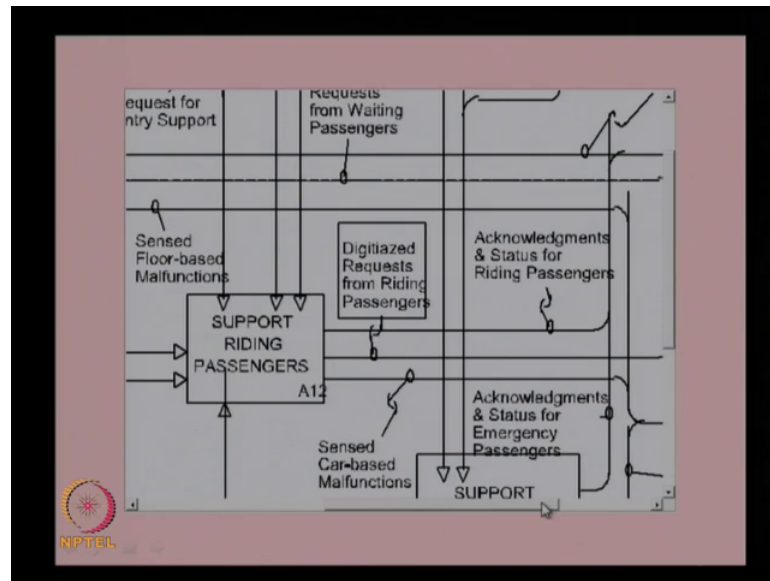

And similarly, acknowledgement and status for riding passengers or riding passengers also will get some acknowledgement and a present status of the elevator or whether the request has been accepted or it has been received. So, that information also will be provided by this particular function.

(Refer Slide Time: 21:19)

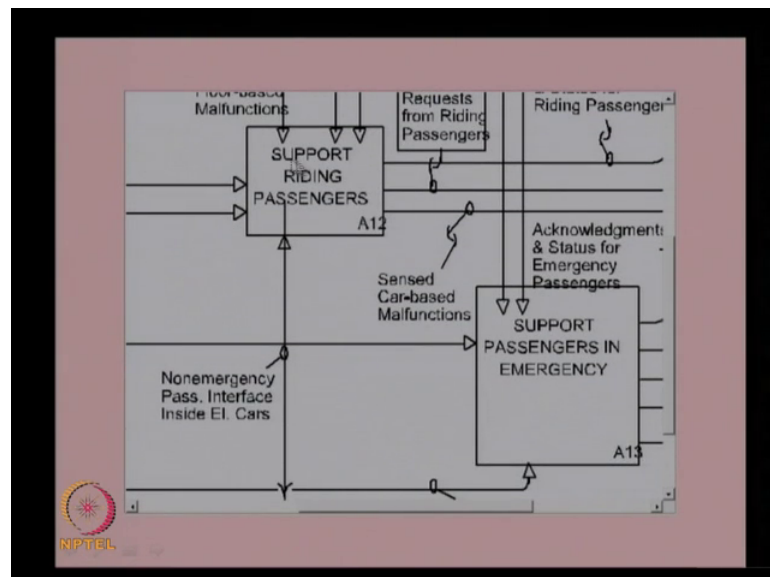

The third one is support passengers in emergency. So, you can see this is first was support to waiting passengers and next one is support riding passengers and the third one is support passengers in emergency. And here also the input basically the input will be

from the passengers riding passengers or the waiting passengers both will be giving a input and the emergency support and emergency message will be the input. You have to send the message and that input will be there and of course, malfunctioning messages also will be coming here.

(Refer Slide Time: 21:49)

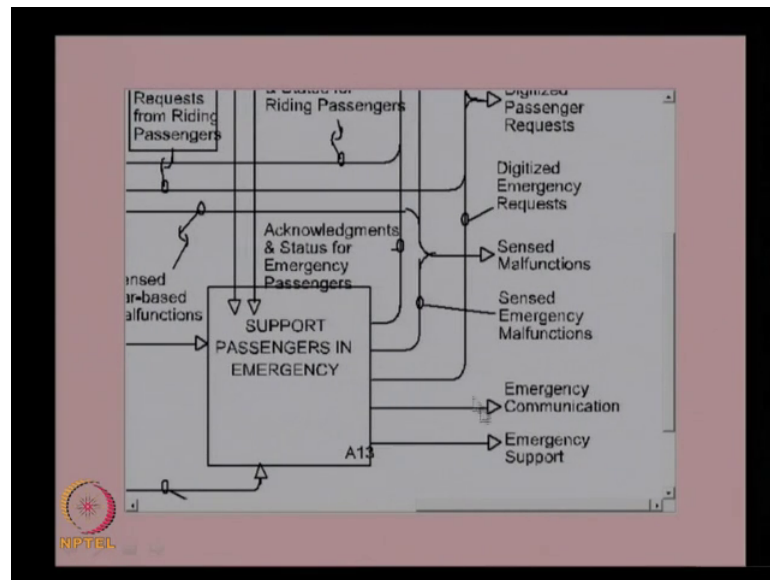

Based on this function will generate necessary control signals, emergency communication signals and emergency support and the information will be passed to other functions also.

So, like this these are the input outputs coming from these functions. As you can see there is lot of interaction between these functions within the system.

(Refer Slide Time: 22:07)

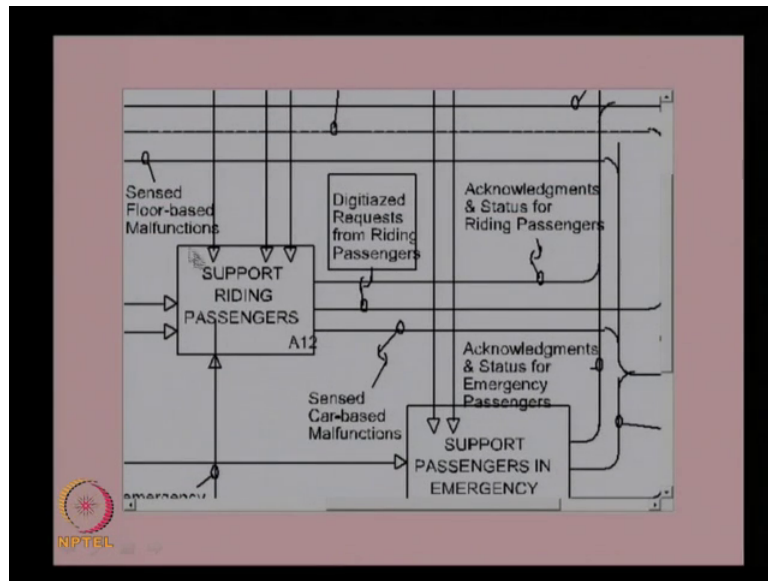

So, the input from one function will be, output from one function will be an input to another function and similarly the output will be can be one function can be input to a previous function also. So, you can divide the main A1 function into A11, A12 and A13 in this diagram. So, this diagram is basically, the A1 diagram where the A1, A2, A11, A12 and A13 functions are decomposed and their interactions are clearly as shown. So, that is the A1 diagram.

(Refer Slide Time: 22:44)

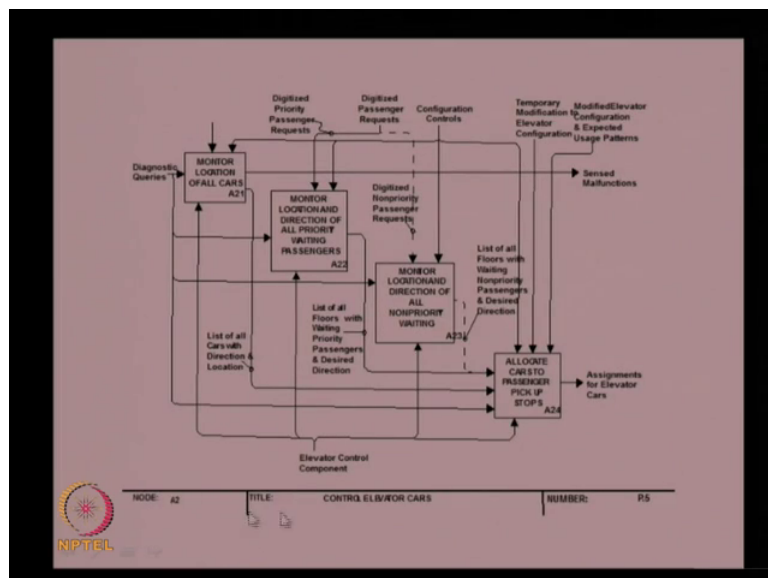

Similarly, we can have A2 diagram also. So, in this A2 diagram we divide the A2 function that is from the A1 or the level 1 diagram you take the A2 function which is the control elevator cars and divide this in to sub functions A21, A22, A23 and A24. As you can see here this is the A21 function which is monitor location of all cars. Basically, in order to control the elevator cars we need to monitor the location of all cars, you need to monitor and location and direction of all priority waiting passengers and we need to monitor the location and direction of all non priority waiting passengers and all allocate cars to passenger pick up stops. These are the sub functions to be provided in this function, that is, control elevator cars need to have these functions in order to satisfy the requirement of controlling elevator cars.

So, the first function is monitor location of all cars. Let us see the input and output of this function as you can see here.

(Refer Slide Time: 23:44)

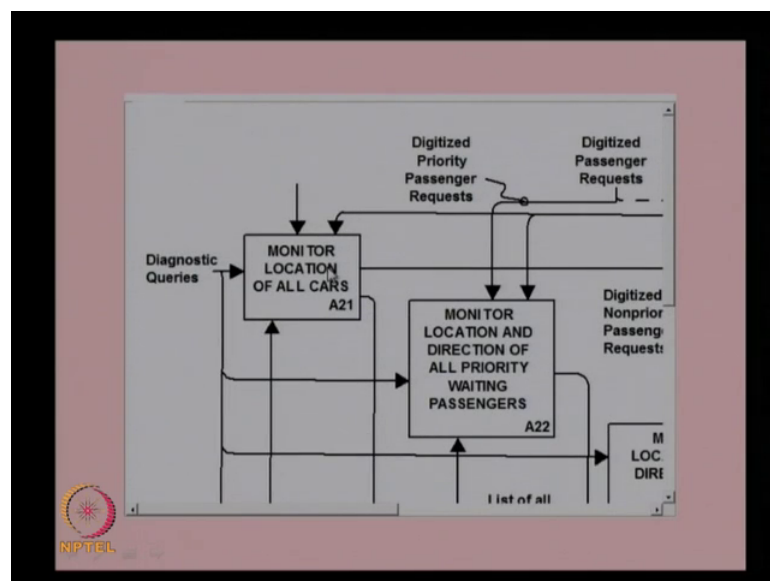

This is the monitor location of the all cars. So, the diagnostic queries will be there and the inputs will be coming from the passenger, output from the location.

(Refer Slide Time: 23:54)

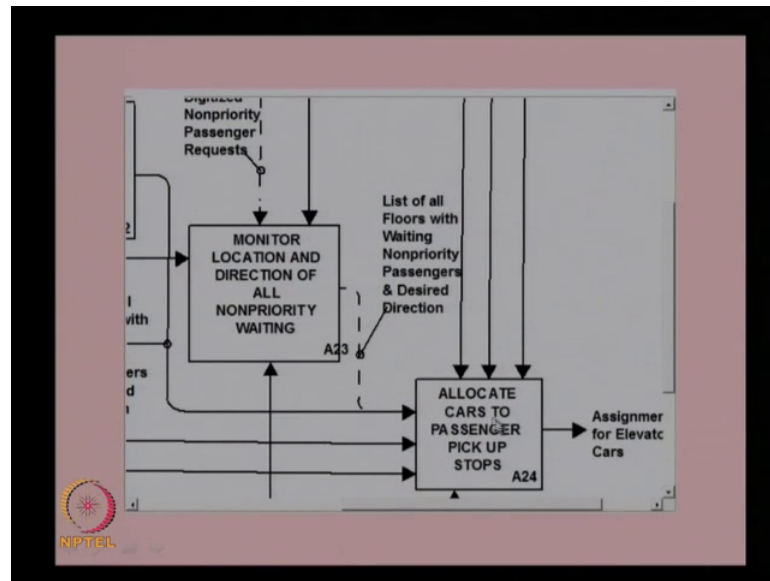

That is this is the one of the input that is allocated cars to passenger that information will be there and that information will be going to this one to monitor the location of the car. So, based on these information it will continuously monitor location of all cars and give this as an output to the other function of allocating the functions. So, and any sensed malfunction also will be given as an output.

(Refer Slide Time: 24:22)

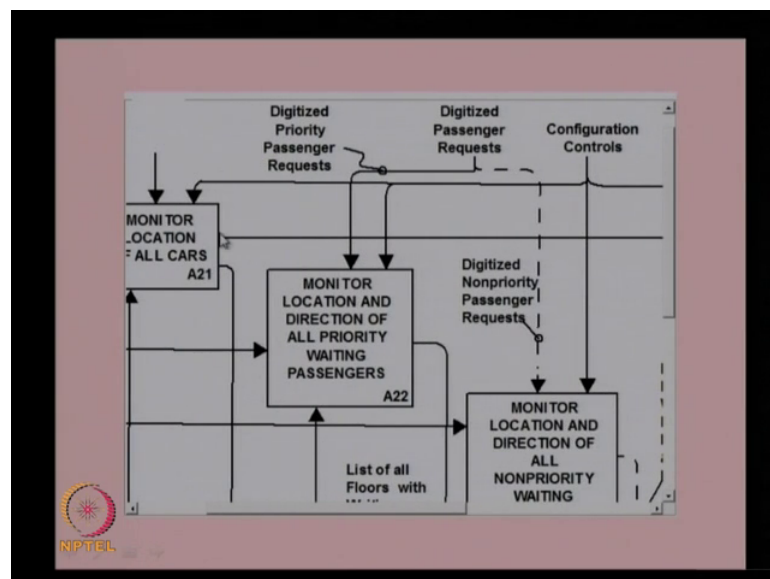

So, there will be an output which actually gives the position of the elevator cars and a malfunctioning of these cars, if any. And other one is monitor location and direction of

all priority waiting passengers. So, priority waiting passengers will be having a separate input processing. So, that data will be coming digitized passenger request will be coming over here and the location of cars also will be coming here. And based on this it will actually locate what the cars are and that information will be send to the next level function or to process the input for the allocating the cars.

(Refer Slide Time: 24:57)

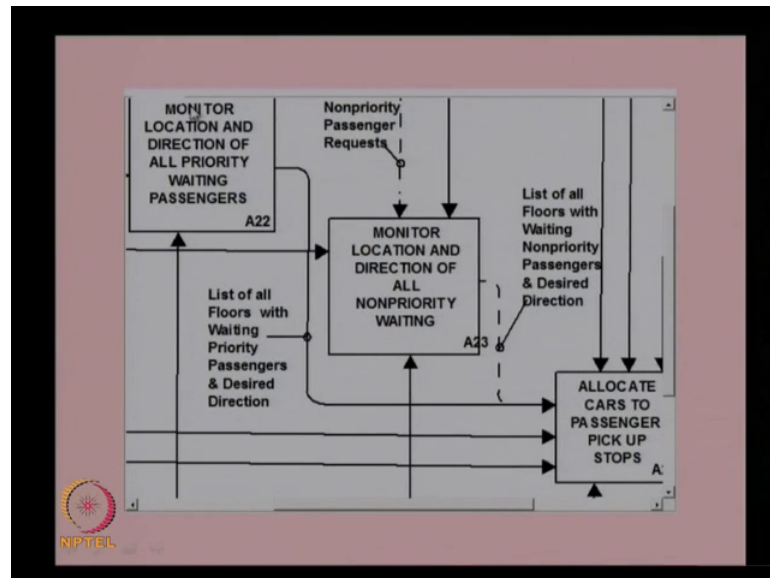

So, this output from here the monitor location and direction of all priority waiting passengers, the output will be send to the allocate cars to passenger pickup and stops. So, list of all floors with waiting priority passengers and desired direction will be sent from here to this function, that is, to allocation of cars. Similarly, the location and direction of all non priority waiting passengers also will be monitored again using the input from the passengers and these inputs will be used to find out where the passengers, whether a non priority passengers are there, what are their request and that is information also will be send to the allocate cars to passenger pick up stops.

So, this is the main function which actually will allocate the cars, but basically it requires the information from these other functions in order to process the information, about the priority passengers and other passengers and based on these inputs, it will allocate the cars to different floors and for different services by this assignment of elevator cars.

(Refer Slide Time: 25:57)

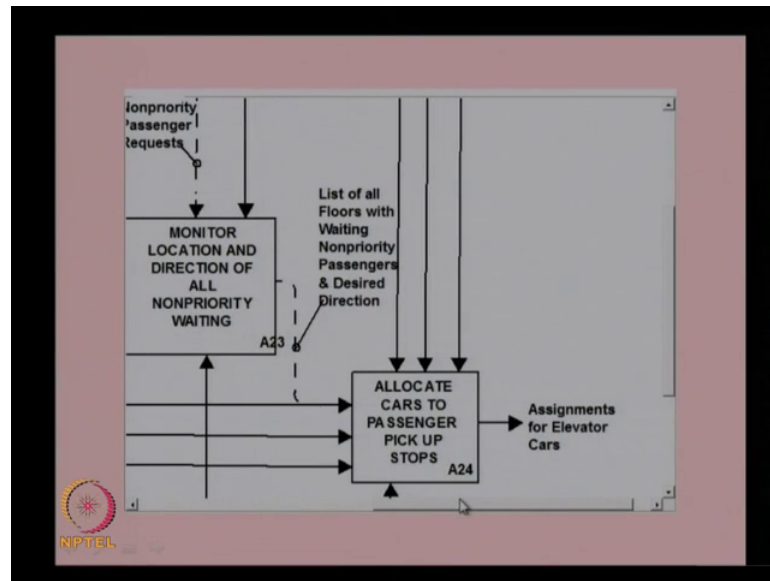

So, we can see here the control elevator cars is a function in order to satisfy the requirement in has to provide the sub functions like monitory location of all cars then monitor location and direction of all priority passengers as well as the monitor location of non priority passengers and this information will be used by the function to allocate cars to different floors. So, that is the decomposition of A2 function in to A21, A22, A23 and A24.

(Refer Slide Time: 26:32)

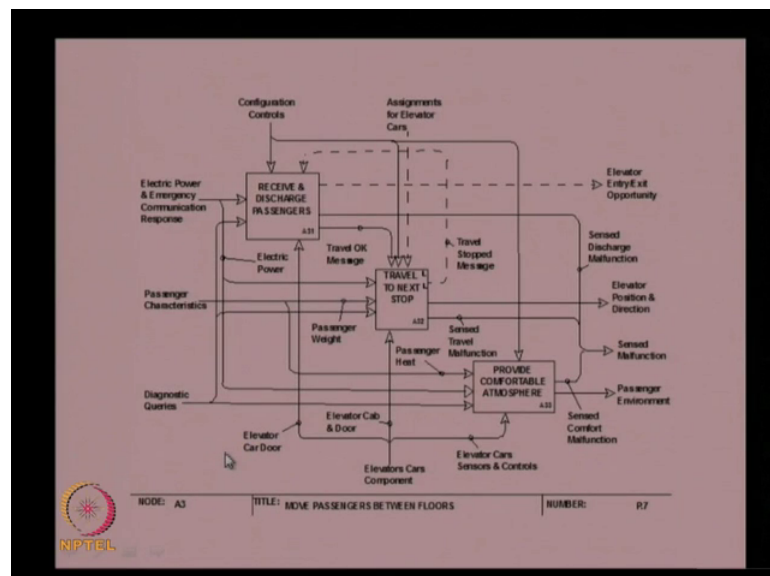

Similarly, we can divide this A3 function which is move passengers between floors, that is, the function A3, again in level 0 diagram we identified these functions A1, A2 A3 and A4. So, based on this we can actually decompose this A3 function into its sub functions. So, move passengers between floors, one sub function is; receive and discharge passengers. So, that is one function we need to receive and discharge passengers. We need to travel to next stop, so the elevator has to travel to the next stop and provide comfortable atmosphere within the elevator.

So, these 3 functions need to be satisfied in order to satisfy the function move passengers between floors. Here, again you can see receive and discharge passengers you can see the inputs are configuration controls and other information coming from the travel stop messages coming from the other elevator cars and then the electric power and other inputs are also here. Similarly, it will get the input from other location like elevator car door status, cars component are the mechanisms which actually use this mechanism to provide the receive and discharge passengers.

So, these are the mechanisms through which the this function will be executed, that is, elevator car doors, elevator car component as the mechanism and that will provide the opening and closing of the doors to receive and discharge passengers and the output will be the sensed discharge malfunction, in case there is any problem with the doors then that will be sensed here and will be send to the maintenance function. And the message will be send to the next one, that is, travelled to next stop that is if the function to receive and discharge passengers has been accepted or it is functioning properly then that message will be send to the next function, basically, it will go to the next floor. If the passengers have been accepted or gone into the car safely or they have been gone out of the car safely then the that message will be send to the elevator when based on that information elevator will be moved to the next floor to accept passengers or to discharge passengers.

That is the next level function travel to next and provide comfortable atmosphere for the passenger. So, that I get, as a function you need to provide good atmosphere within the car, that again is a function. So, there will be many systems inside to provide the comfort to the passenger like the fan or air conditioning or other emergency services. So, all those services will be monitored and in case of any malfunction that will be send that information will be processed and send to the maintenance function. So, that passenger

will be always getting a good comfortable atmosphere within the car. So, in order to move passengers between floors we need to provide these functions within the elevator.

Otherwise you will be not able to provide the necessary satisfaction to the customer. So, the sub functions are receive and discharge passengers, travel to next stop and provide comfortable atmosphere. All these are and then the passenger environment and sensed malfunction, elevator position and direction and discharged malfunction and these are all the output coming from this function A3. And A3 outputs we actually saw in the previous diagram or the level 1 diagram we can see the same outputs will be coming here also, but they will be coming from different functions. It not from the same function there will be many sub functions and some of these sub functions will be providing this output.

So, we need to find out which function is providing the output and accordingly we need to design the system so that it will take the input and provide the output to the next system or the next sub system. So that is the A3 diagram, where it show the decomposition of A3 to A31, A32, A33. So, this the detailed diagram here.

So, receive and discharge passengers and travel to next stop A32 function and then you have this provide comfortable atmosphere to the passengers. So these are the sub functions and the outputs are here passenger environment, sensed malfunction, elevator position and these are the outputs and these are the inputs electric power emergency communication, passenger characteristics and the controlled inputs are configuration controls and assignment of elevator cars.

So, these are the control inputs coming to this A3 function and these are the outputs coming from A3 function and this A3 function is providing these outputs through sub functions A31, A32 and A3.

(Refer Slide Time: 31:25)

Evaluation of Functional Hierarchy: Scenario Tracing

Shortfall: is the absence of a functionality that is required to produce a desired output.

- Absence of the proper functionality
- Inability to produce a desired output
- Insufficient control signals to produce O/P

overlap: is a redundancy in functionality that is needed to achieve additional performance.

Functional overlaps, unlike physical overlaps, are not needed



So, that is the way, how we actually divide these functions using IDEF0 diagram. As we can see that in the top context level diagram we have the A0 function alone and then the level 1 function or the A0 diagram we divide this A0 function into sub functions A1 A2 A3 etcetera and then in the next level we divide this A1 function into its sub function A11, A12, A13 or A21, A22, A23.

And again if you go to the next level this A21 function will be further divided into A211, A212, A213 etcetera. So, like this we will keep on dividing these functions till we reach the stage where we know that we do not really need to decompose these functions because some of these functions will reach to the lowest level of function where we can really identify a component which can actually provide that function. But, till then we will keep on decomposing these function into the sub function and provide the, get the other sub functions.

And we will be getting many other diagrams like in A0 diagram, A1 diagram, A2 diagram or level 1, level 0, level 1, level 2 diagrams and all these diagrams can be combined together to find out all other functions and then based on these we can create a functional hierarchy of the system or the functions can be used to get the functional structure of the system. Basically, we are decomposing the main function into the sub functions of the system.

But, one advantage of using IDEF0 diagram is to look at the scenario or that to evaluate the functional hierarchy, whether we are providing all those functions or we are missing some of the functions in the system. That can be done using the functional hierarchy or scenario tracing.

Basically, the scenario tracing will identify 2 things; one is the shortfall of the functions. Now, shortfall is basically the absence of a functionality that is required to produce a desired output. So, we know that there is an input and there is an output and when we go through the scenario we see that there is one function we see which actually converts an input to output. So, that the absence of the functionality can be identified and this is known as the short fall of functions. Or the inability to produce a desired output or functions identified cannot produce an output which actually you want or insufficient control signals to produce the output or the control signal provided is not sufficient to produce the output. So, these are known as the shortfall in functional hierarchy.

So, we use these diagrams to find out where there is any shortfall in the functions to be identified. It can be an absence or it can be an inability to produce an output or it can be a absence of a control input to produce the output and there is another one called overlap which is a redundancy in functionality that is needed to achieve additional performance. So, sometimes we provide the additional functions it may a redundant and may not be required at that point or that location. So, that can be identified using scenario tracing. The functional overlaps unlike physical overlaps are not needed. We do not really need to have functional overlaps; of course, we will provide physical overlaps in order to provide the redundancy in the hardware.

But, in the functional overlap is not needed, if you can identify a function one function is sufficient to produce an input an output from an input. We do not need to have an alternate another function to do that. So, that actually can be avoided overlap. So, if you go through the scenario tracing, we can identify the shortfall as well as the overlap of functions and check whether functional hierarchy is proper or whether any modifications are needed in the functional hierarchy. Let us see how we are do this using IDEF0 diagram.

(Refer Slide Time: 35:33)

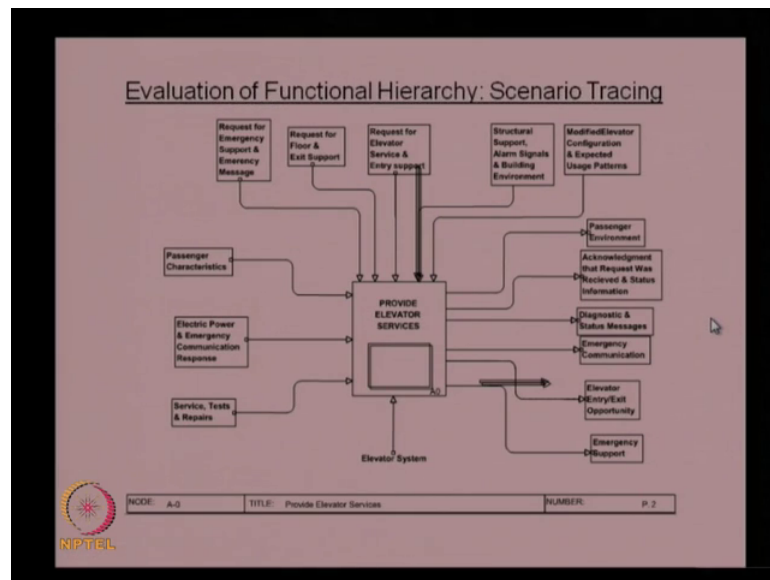

So, as I mentioned earlier, from the context diagram we can actually take any one of these inputs and you see what is the output coming from there and then we can find out what is happening to these input, as if the input goes through different functions. So, this is known as the scenario tracing. In this case, we take the request for elevator service and entry support as an input and see the output as elevator entry exit opportunity. So, customer is giving, different diagram.

(Refer Slide Time: 36:06)

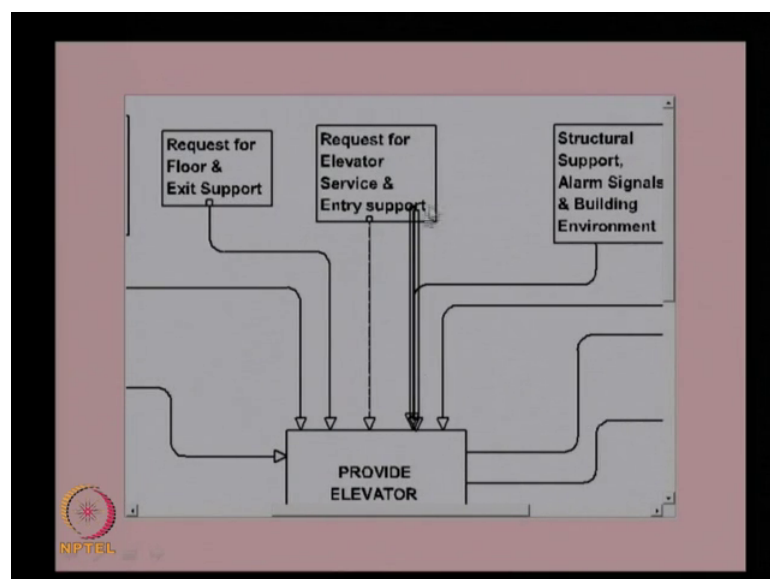

So, we can see here the request for elevator service and entry support as a input. So, we want to find out, what to trace the scenario, what actually happens once customer gives a request for elevator service. The customer is giving for service for the elevator service and based on this request the elevator will function and provide an output of entry exit opportunity. So, that is the final output coming from the elevator for this input.

(Refer Slide Time: 36:36)

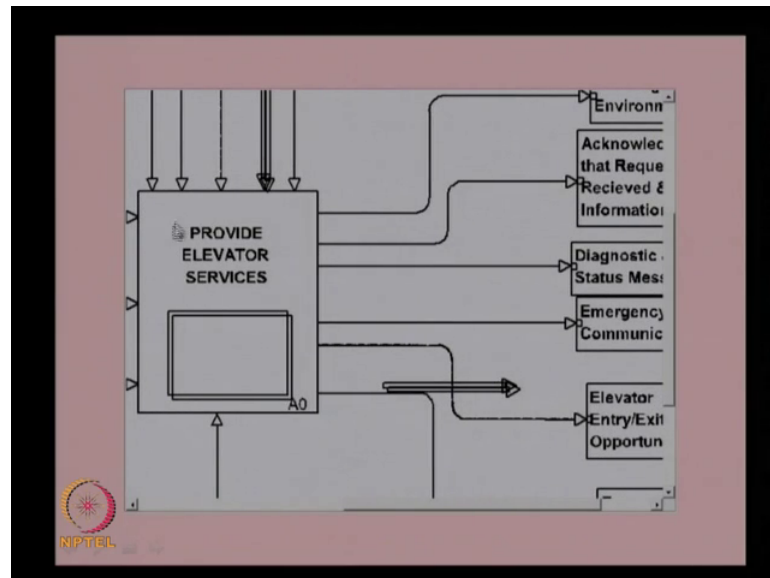

But, what is happening to this input within the functions or within the sub functions and how this input is converted to an output of like this. So, we trace this scenario and try to find out all the functions which actually in between and how this input is converted to an output. That is known as the scenario tracing and we use that one to find out the absence of any functions or overlap of the functions.

(Refer Slide Time: 37:03)

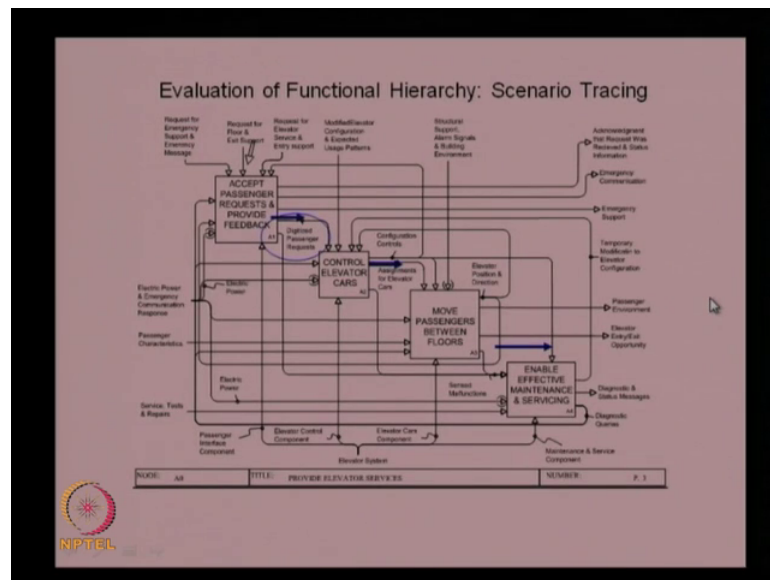

So, this is the A0 diagram. So, we started from the context diagram. In the context diagram the input is given to the system and an output is coming from the system and now we will look at the A0 diagram where the sub functions are there and we try to trace the input.

(Refer Slide Time: 37:24)

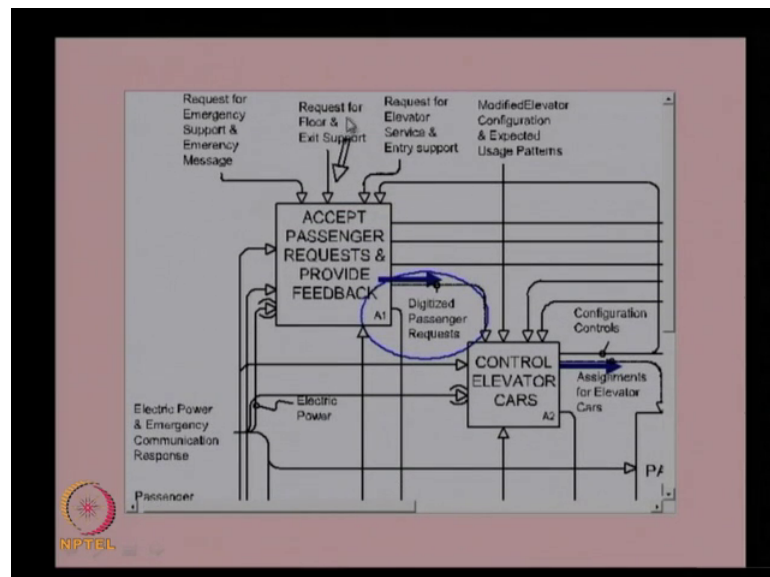

So, here we take the input from here, you can see, this is the input; request for floor and exit support. That is actually coming to function A1 and from A1 it is going as digitized

passenger request. So, this request is processed here in A1, it is going as digitized passenger request and that request is going to A2 function, it is control elevator car.

(Refer Slide Time: 37:45)

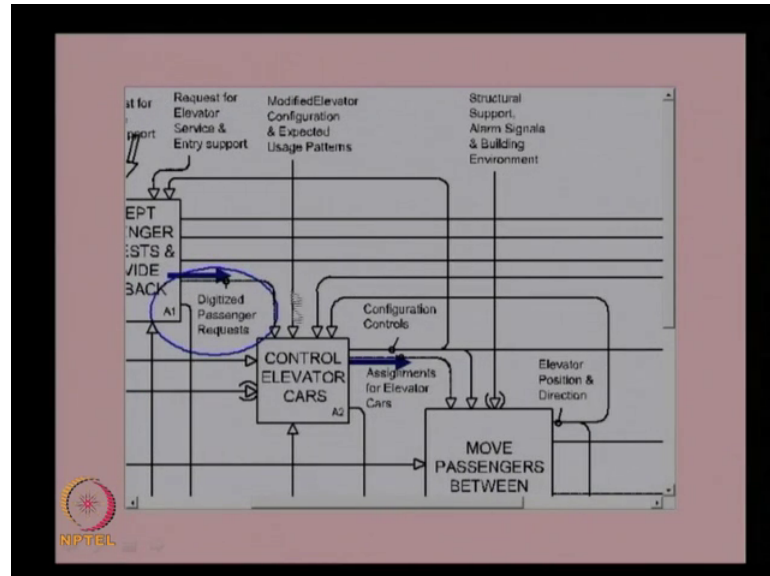

And then control elevator car is giving the assignment of elevator cars and that is the output from here for the same input of request that is converted to digitized request and that is coming to control elevator cars as a control input and then controlled assignment of a elevator car is coming as an output from this function assignment of control of elevator cars and then it is going to the next function which is move passengers between floors and here you are getting an output.

(Refer Slide Time: 38:13)

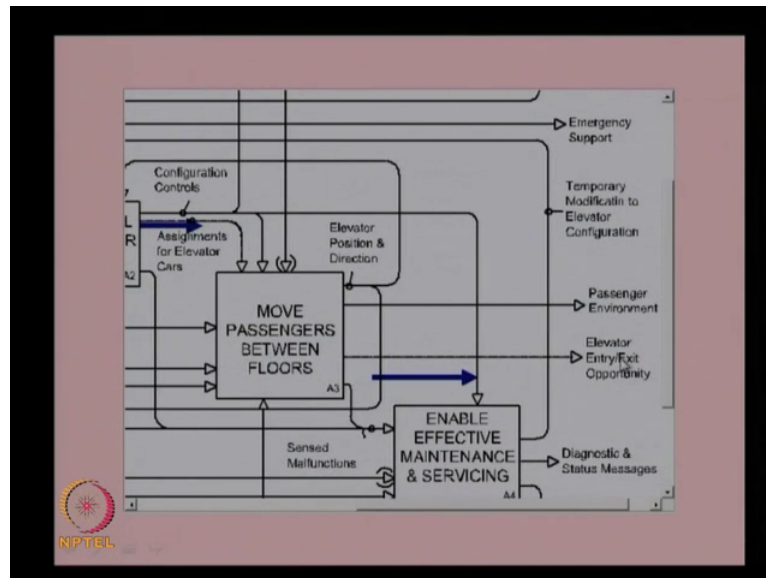

That is the elevator entry exit opportunity. So, we are actually tracing that input which is the request for entry exit or the elevator service and that request is being processed in these functions and coming out as a output of elevator entry exit opportunity. So, you can see that this A1, A2 and A3 functions are using this input and processing these inputs to various forms and then getting the final output. As we can see here A4 function is not using that input and therefore, we do not need to look at the A4 function for further tracing of this signal.

So, now if we want to find out what is happening to this signal in this function A1, we have to go to the next level or the A1 diagram or level 2 diagram and then find out what is happening to this in input, so, request for floor and exit support. Similarly, what is happening to the digitalized passenger request and how is it converted to elevator cars we need to go in to this function and then find out the path through which the signal is passing. So, we will go through this and different these stages I mean we will go to the A1 function and it is sub functions similarly A2 and it is sub functions and A3 and it is sub functions to find out the scenario, to trace the scenario of the passenger request. So, here you can see these request is converted to a digitized passenger request.

We know that there can be a function which actually converts this input and that is what we need to find out whether there is any short form or any overlap of functions in this one conversion of passenger request to digitized passenger request.

(Refer Slide Time: 39:50)

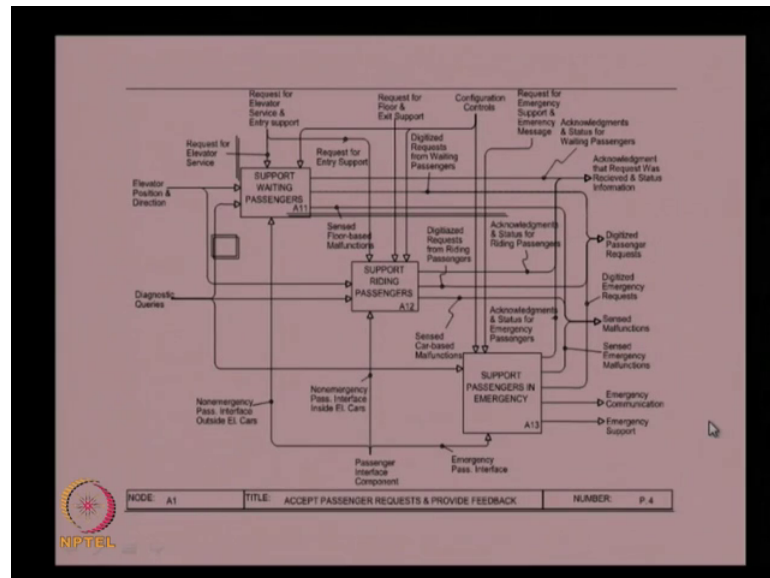

So, what we are doing is going to the A1 diagram; that is A11 function, A12 function, A13 function and seeing that actually happens to this request.

(Refer Slide Time: 40:04)

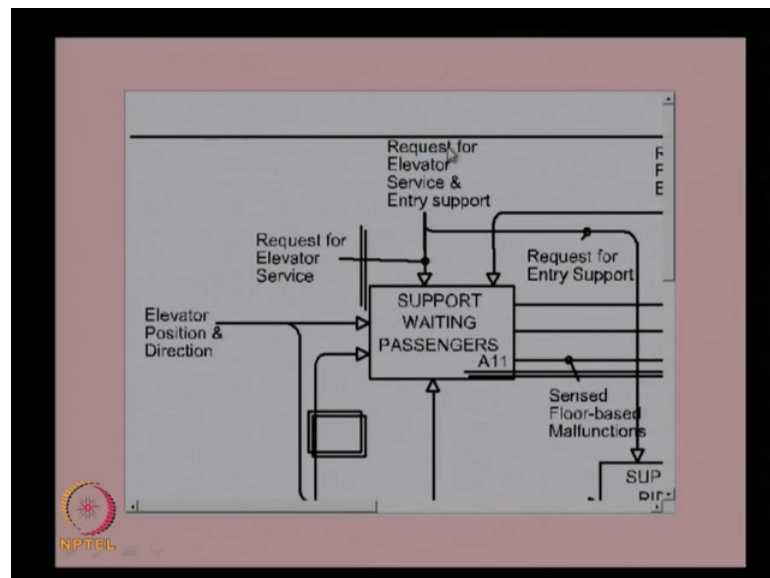

Again we will see; so, this is the request for elevator service. So, that is the coming here, support waiting passengers and then support waiting passengers.

(Refer Slide Time: 40:14)

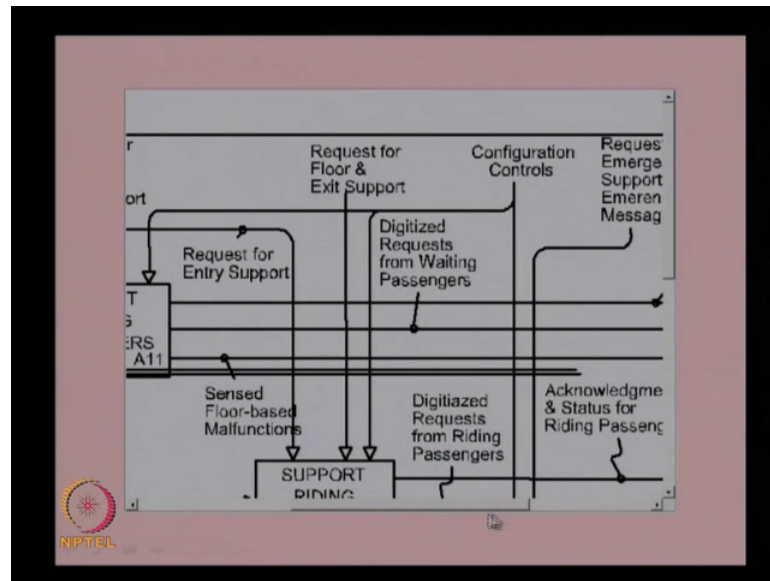

The data is coming here and going out as acknowledgement or status for riding passengers and then the digitized passenger request from waiting passengers and request from entry support is coming over here.

So, actually you can see that this function is coming here and going out from here.

(Refer Slide Time: 40:38)

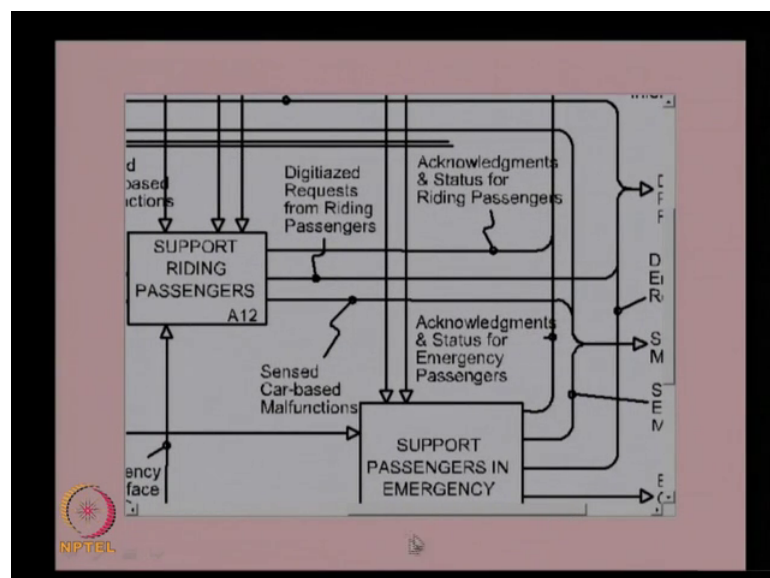

Similarly, you can actually see the acknowledgement and the status for riding passengers is coming from these functions. So, both the functions, supports waiting passengers

function and the support riding passengers function both are using the request of entry A4 support signal and converting that into digitalized output.

(Refer Slide Time: 41:03)

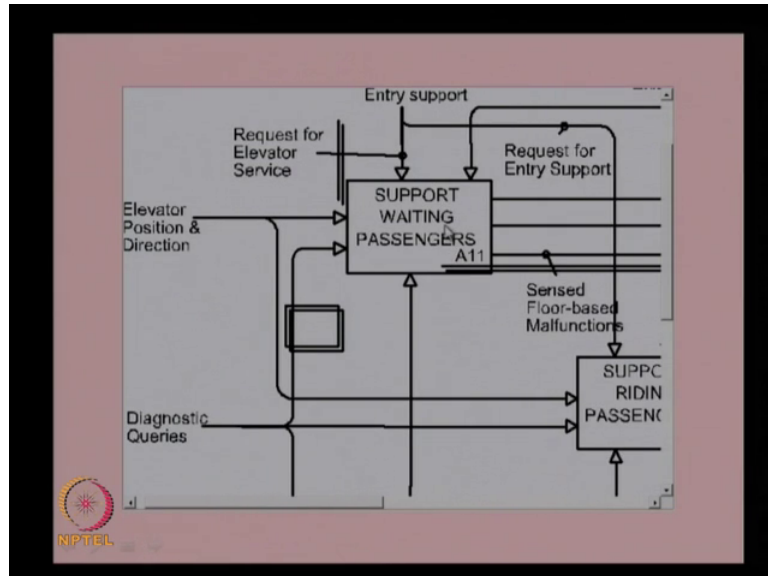

So, again if you further down into A1 you can see that there will be a component or electronic component, which actually convert the signal to digital signal and sending it to the next function.

(Refer Slide Time: 41:13)

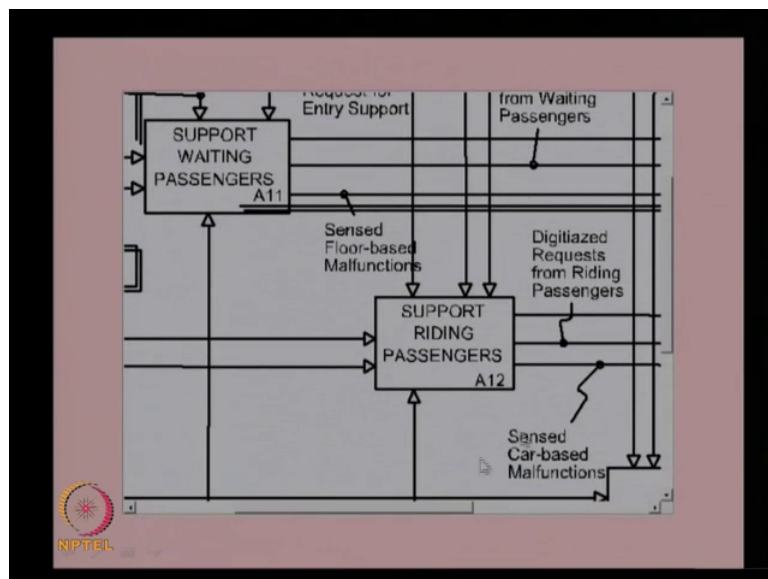

So, A1 as well as A12 are providing the digitized, using this signal and giving the international out to the next level function. In order to find out the function we need to

go further deep into the support waiting passengers and then go into it and the see what is the happening to this signal or which is the function which actually it transfers this signal to digital signals.

So, this is the way how we actually trace the scenario. We go through each input and find out all the functions through which passes and try to find out whether that function is really capable of transferring the input or output or if there any overlap of function which actually which is redundant in transferring the input to output. That can be done through this diagram. So, we go through each and every function through which the signal passes and finally, identify all the functions which correspond to that signal and then look for any shortfall or overlap. So, that is the way how we actually process the signal here or process the moves that I IDEF0 diagram to trace the scenario.

So, this is basically about the IDEF0 diagram and how this can be used for functional decomposition. So, what we discussed here was to look at the IDEF0 diagram as such basically it is a integrated definition for system functional decomposition, which was developed basically for aircraft design or air system design. We know that there are context diagrams. There are this context diagram is basically giving the top level function and then identifies all the inputs, outputs, controls and the mechanism and then from the context diagram the function can be decomposed into sub functions A1, A2, A3 which is A0 diagram we represent it.

And then A1 function can be further decomposed in A1 diagram where the A11, A12 etcetera. So, like this we can keep on decompose these functions and finally, get all the sub functions. That is the advantage of using an IDEF0 diagram. It is a graphical representation where we use the text also to represent the inputs and outputs.

Apart from the representation, we can use this for tracing the scenario to find out the short fall or overlap of functions also. We can see few more examples in the next class. So, in the next lecture I will take one simple example and then show you how to use this diagram in order to decompose a system top level function into sub functions. So, till then bye.